

Making Better Automation to Build Your Success

WECON®
Distribution in Poland

info@we-con.pl
+48 533 306 962
+48 533 306 961

ISO | CE | FC



PRODUCTS CATALOG

Human Machine Interface/Programmable Logic Controller/
Servo Drive & Motor/IIoT V-BOX/Inverter





FUJIAN FUCAN WECON CO.,LTD.

WECON is a high technology company on automation and its solution, headquartered in Fuzhou software park, Fujian China. Wecon dedicates all the efforts to provide integrated products and solution on automation, such as Human Machine Interface (HMI), Programmable Logic Controller (PLC), Servo Drive&Motor, IIoT V-BOX and Inverter.

WECON has modernized factory over 10,000 square meters in Fuzhou, the R&D and production department strictly follows ISO9001 quality management system, and all products are certificated by CE and FCC. The R&D center has more than 3,000 square meters in Fuzhou, with more than 150 R&D engineers work here.

Until 2024, WECON have been authorized over 160 independent intellectual property rights, which includes 11 Invention Patents, 28 Utility patents, 9 Design Patents, and 116 software intellectual property rights. WECON has over 40 domestic offices all over China, more than 30 foreign distributors in 22 countries. WECON business covers most main industrial countries, locating in Asia, Europe, North America, South America, Oceania and Africa.

2019 is an important year of WECON globalization. In this time, we start to have international employees, now have employees from Turkey, Egypt, and Brazil. They are dedicated efforts and wisdom to support customers success and improve the industry level of the world. WECON provides services such as technical support and maintenance all over the world. Overseas customers could buy products and enjoy services locally and conveniently.

Content

About WECON	01	WECON SERVO Drives	
WECON Products	03	Servo Drives Features	31
WECON HMI		Servo Applications	32
HMI Features	05	Servo Naming Rules	33
ig Series IoT HMI	06	Servo Driver&Motor Specifications	34
PI8150ig High Definition IoT HMI	07	VD3E Series Servo Features	35
PI3000ie Series HMI	08	Servo Specifications	36
ig Specifications	09		
PI3000ie Specifications	12	WECON V-NET&V-BOX	
PI3000i Specifications	13	V-NET Architecture	39
WECON PLC		V-NET Functions	40
PLC Features	15	V-BOX Features	41
PLC Applications	16	V-BOX Applications	42
LX6V/6S Series PLC	17	V-BOX E Series Specifications	43
LX6C Series PLC	19	V-BOX H Series Specifications	44
LX5V Series PLC	21	V-BOX RE&RH Series Specifications	45
LX5S Series PLC	22	INVERTER	
Expansions Modules&BD Modules	23	VB Series AC Drive	47
LX6V&LX5V&LX5S PLC Models	24	VM Series AC Drive	51
LX3V Series PLC Models	25		
LX5V General Specifications	27		
LX5S General Specifications	28		
PLC General Specifications	29		

Data



Control



Drive

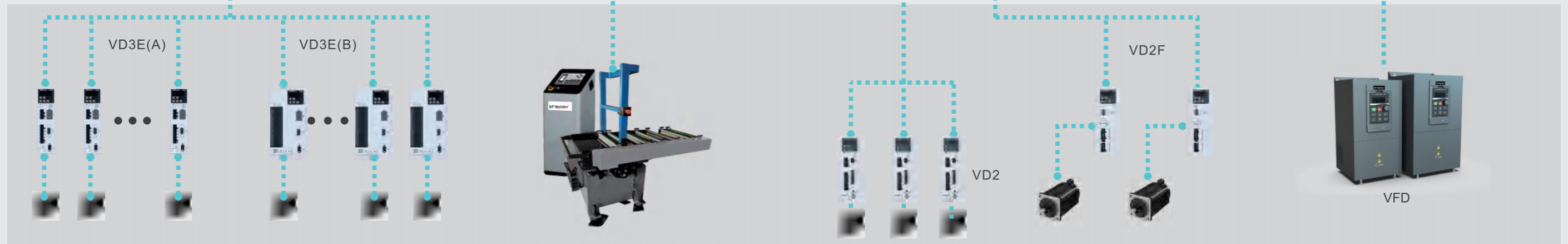

Smart Treatment for Water



Smart Factory



Automatic Plug Wiring Machine



Textile Machinery

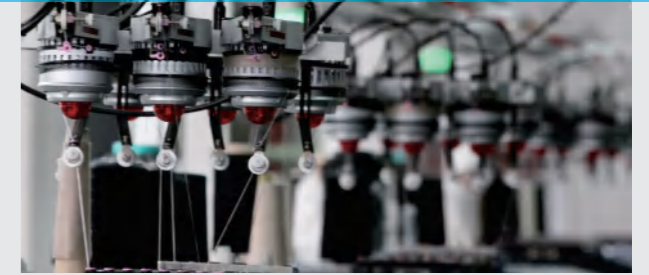

ig Series IoT HMI

ig IoT HMI, create for the Internet of Things



PI8150ig High Definition IoT HMI

Aluminium Alloy Panel

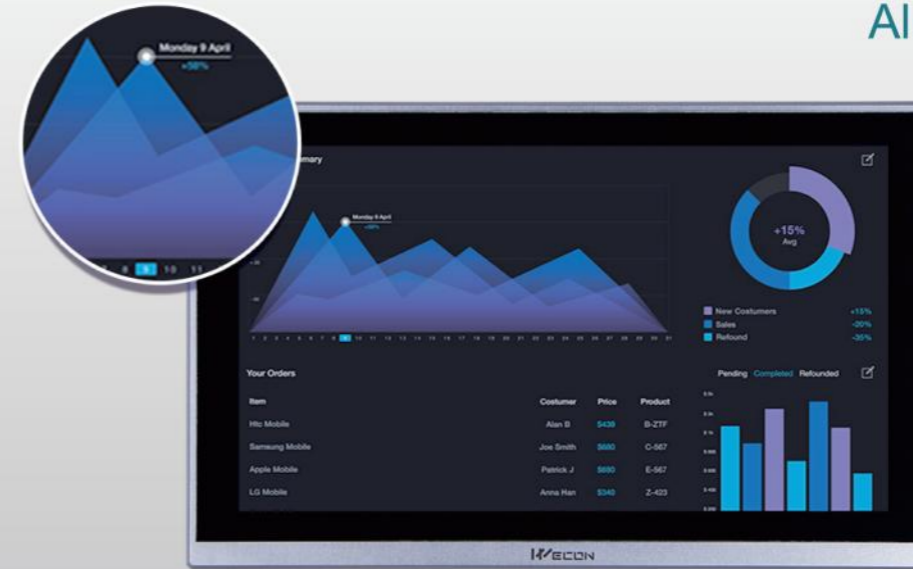

High-definition
Wide Viewing Angle

Device Management

- Multi-device management
- Multi-authority account



Alarm Notification

- Alarm SMS push(4G models)
- Upload and download alarm records



Big Screen

More convenient operation
Display in high-definition and high quality



1920×1080

Aluminium Alloy Panel

Strong anti-interference, excellent heat dissipation
Anti-corrosion, and high temperature resistance



Remote Maintenance

- Sync data to cloud
- Remote access
- WVPN pass-through
- Remote debug

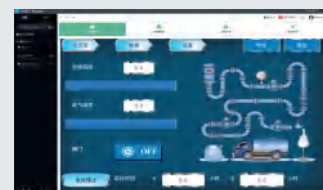

System Integration

- Cloud SCADA
- Big screen display
- Equipment connection



4-core CPU

With Cortex A35 1.2GHz high performance processor
PI8150ig has powerful operation processing capability

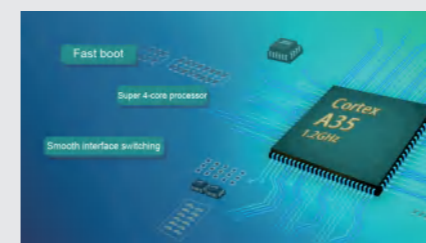

Complete IoT Functions

MQTT cloud protocol and database server connection
Supported more powerful IoT functions

- Real-time Monitoring Points: 300
- Alarm Monitoring Points: 200
- History Monitoring Points: 100
- History Storage: 120 days / 1 millions

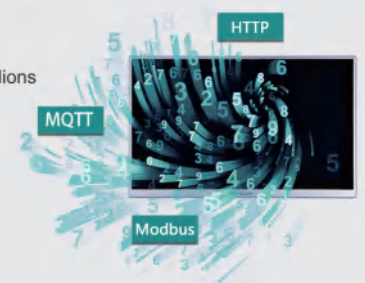

ig SPECIFICATIONS

IOT HMI



Model

PI3070ig PI3102ig PI3070ig-O-H PI3102ig-O-H

Item	Specifications				
CPU	HighPerformanceCPU				
Touch Screen	Resistive				
Display	Screen Size	7 Inch	10.1 Inch	7 Inch	10.1 Inch
	Resolution	800*480	1024*600	1024*600	1024*600
	Brightness	250 cd/m ²	350 cd/m ²	250 cd/m ²	350 cd/m ²
	BacklightType	LED			
	BacklightLife	50,000 Hours			
Storage	Flash	128MB			
	RAM	128MB			
	SD Card	YES			
I/O Port	USB	USB Host: USB 2.0 x 1; USB Client: USB 2.0 x 1 (can not be used at the same time)			
	Serial Port	Type 1: COM1(RS232), COM1(RS485), COM1(RS485) Type 2: COM1(RS232), COM1(RS422), COM1(RS485)			
	Ethernet	YES			
	CAN	N/A			
	4G/WIFI Module	Optional	N/A		
Permanent Calendar	Built-in				
Power	Power Supply	24V DC (12-28V DC)			
	Power Consumption	<8W	<10W	<8W	<10W
Dimension	Enclosure	Plastic+ABS (Polycarbonate)			
	Dimension(mm)	201.2W*147.2H*39.0D	272.0W*191.0H*41.5D	201.2W*147.2H*39.0D	272.0W*191.0H*41.5D
	Mounting Size(mm)	192.0W*138.0H	260.0W*179.0H	192.0W*138.0H	260.0W*179.0H
	NetWeight(KG)	0.52	1.02	0.52	1.02
Environment	Protection	IP65 (Frontpanel)			
	Temperature	Storage: -20°C~70°C Working: -10°C~55°C			
	Humidity	10 ~ 90%RH (Non-condensing)			
	VibrationResistance	10 ~ 25 Hz (X, Y, Z direction 2G/30minutes)			
CE Certification	CE Marked				
FCC Certification	FCC Class A				
Programming Software	PI Studio				
IoT Service (optional)	Real-time Monitoring Points	100	N/A		
	AlarmMonitoring Points	20	N/A		
	HistoryMonitoring Points	50	N/A		
	HistoryStorage	60 days / 1 millions	N/A		
VPN Pass-through	YES	N/A			

ig SPECIFICATIONS

Advanced HMI



Model

PI8043ig PI8070ig PI8102ig PI8150ig

Item	Specifications				
CPU	HighPerformanceCPU				
Touch Screen	Resistive				
Display	Screen Size	4.3 Inch	7 Inch	10.1 Inch	15 Inch
	Resolution	480*272	800*480	1024*600	1920*1080
	Brightness	300 cd/m ²	250 cd/m ²	350 cd/m ²	250 cd/m ²
	BacklightType	LED			
	BacklightLife	50,000 Hours			
Storage	Flash	4GB			
	RAM	512MB			
	SD Card	N/A	YES	YES (TF Card)	
I/O Port	USB	USB Host: 2.0 x 1; USB Device: Type-C 2.0 (can not be used at the same time)	USB Host: 2.0 x 1; USB Client: USB 2.0 x 1 (can not be used at the same time)		
	Serial Port	Type 1: COM1(RS232), COM1(RS485), COM1(RS485) Type 2: COM1(RS232), COM1(RS422), COM1(RS485)			
	Ethernet	YES			
	CAN	N/A			
	4G/WIFI Module	Optional			
Permanent Calendar	Built-in				
Power	Power Supply	24V DC (12-28V DC)			
	Power Consumption	<8W	<10W	<15W	
Dimension	Enclosure	Plastic+ABS (Polycarbonate)			Aluminum+Metal + ABS
	Dimension(mm)	142.0W*86.0H*30.5D	201.2W*147.2H*39.0D	272.0W*191.0H*41.5D	403.0W*253.0H*35.2D
	Mounting Size(mm)	131.0W*78.0H	192.0W*138.0H	260.0W*179.0H	394.0W*244.0H
	NetWeight(KG)	0.39	0.52	1.02	2.46
Environment	Protection	IP65 (Frontpanel)			
	Temperature	Storage -20°C~70°C Working -10°C~55°C			Storage -20°C~60°C Working 0°C~50°C
	Humidity	10 ~ 90%RH (Non-condensing)			
	VibrationResistance	10 ~ 25 Hz (X, Y, Z direction 2G/30minutes)			
CE Certification	CE Marked				
FCC Certification	FCC Class A				
Programming Software	PI Studio				
Software	IoT Service (optional)	Real-timeMonitoring Points 300			
		AlarmMonitoring Points 200			
		HistoryMonitoring Points 100			
	VPN Pass-through	HistoryStorage : 120 days / 1 millions YES			

PI3000ie SPECIFICATIONS

Economical HMI



Model	PI3035ie	PI3043ie	PI3043ieS-N	PI3043ie-T
-------	----------	----------	-------------	------------

Item	Specifications				
CPU	CortexA35				
Touch Screen	Resistive				
Display	Screen Size	3.5 Inch	4.3 Inch	4.3 Inch	4.3 Inch
	Resolution	320*240	480*272	480*272	480*272
	Brightness	300cd/m ²			
	BacklightType	LED			
	BacklightLife Time	50,000 Hours			
Storage	Flash	128MB			
	RAM	64MB			
	SD Card	N/A			
	RTC	Real Time Clock			
I/O Port	MicroUSB	USB 2.0 x 1			
	Serial Port	Type 1: COM1(RS232), COM1(RS485)	Type 1: COM1(RS232), COM1(RS485)	Type 1: COM1(RS232), COM1(RS485), COM1(RS485)	Type 1: COM1(RS232), COM1(RS485)
		Type 2: COM1(RS232), COM1(RS422)	Type 2: COM1(RS232), COM1(RS422)	Type 2: COM1(RS232), COM1(RS422), COM1(RS485)	Type 2: COM1(RS232), COM1(RS422)
	Ethernet	N/A	N/A	YES	N/A
	Permanent Calendar	Built-in			
Power	Power Supply	24V DC(12~28VDC)			
	Power Consumption	< 5W			
Dimension	Enclosure	Plastic+ABS (Polycarbonate)			
	Dimension(mm)	96.0W*81.0W*33.0D	142.0W*86.0H*30.3D		142.0W*86.0H*30.9D
	Mounting Size (mm)	91.0W*73.0D	131.0W*78.0H		131.0W*79.0H
	NetWeight(KG)	0.14	0.19		0.21
Environment	Protection	IP65 (Frontpanel)			
	Temperature	Storage: -20°C~70°C; Working:-10°C~55°C			
	Humidity	10 ~ 90%RH (Non-condensing)			
	VibrationResistance	10 ~ 25 Hz (X, Y, Z direction)2G/30minutes)			
CE Certification	CE Marked				
Programming Software	PI Studio				
Remote Control	N/A				

PI3000ie SPECIFICATIONS

Economical HMI



Model	PI3070ie	PI3102ie
-------	----------	----------

Item	Specifications		
CPU	CortexA35		
Touch Screen	Resistive		
Display	Screen Size	7 Inch	10.2 Inch
	Resolution	800*480	1024*600
	Brightness	250 cd/m ²	350 cd/m ²
	BacklightType	LED	
	BacklightLife Time	50,000 Hours	
Storage	Flash	128MB	
	RAM	64MB	
	SD Card	NA	
	USB	USB Host: USB 2.0 x 1; USB Client: USB 2.0 x 1	
Ports	Serial Port	Type 1: COM1(RS232), COM1(RS485) Type 2: COM1(RS232), COM1(RS422)	
	Ethernet	N/A	
	Permanent Calendar	Built-in	
Power	Power Supply	24V DC(12~28V DC)	
	Power Consumption	< 8W	< 10W
Dimension	Enclosure	Plastic+ABS (Polycarbonate)	
	Dimension(mm)	201.2W*147.2H*39.0D	272.0W*191.0H*41.5D
	Mounting Size (mm)	192.0W*138.0H	
	NetWeight(KG)	0.52	1.02
Environment	Protection	IP65 (Frontpanel)	
	Temperature	Storage: -20°C~70°C; Working -10°C~55°C	
	Humidity	10 ~ 90%RH(Non-condensing)	
VibrationResistance	10 ~ 25 Hz (X, Y, Z direction)2G/30minutes)		
CE Certification	CE Marked		
Programming Software	PI Studio		
Remote Control	N/A		

PI3000i SPECIFICATIONS

Basic HMI



Model	PI3070i	PI3070i-2S	PI3070i-A	PI3070i-SL
-------	---------	------------	-----------	------------

Item	Specifications			
CPU	CortexA7			
Touch Screen	Resistive			
Display	Screen Size	7 Inch		
	Resolution	800*480		
	Brightness	250 cd/m ²		
	Backlight Type	LED		
	Backlight Life Time	50,000 Hours		
Storage	Flash	128MB		
	RAM	128MB		
	SD Card	NA	YES	YES
	RTC	YES		
I/O Ports	USB	USB Host: USB 2.0 x 1; USB Client: USB 2.0 x 1		
	Serial Port	RS232, RS422/RS485 (2 in 1)	COM1: RS232,RS422/RS485	
			COM2: RS232,RS485	
			COM3: RS485	
	Ethernet	N/A	YES	YES
CAN	N/A	N/A	YES	
Permanent Calendar	Built-in			
Power	Power Supply	24V DC(12~28VDC)		
	Power	< 8W		
Dimension	Enclosure	Plastic+ABS (Polycarbonate)		
	Dimension(mm)	201.2W*147.2H*39.0D	200.0W*146.0H*36.5D	191.2W*137.2H*41.0D
	Mounting Size	192.0W*138.0H	192.0W*138.0H	172.0W*111.0H
	NetWeight(KG)	0.51	0.51	0.52
Environment	Protection	IP65 (Frontpanel)		
	Temperature	Storage: -20°C~70°C; Working: -10°C~55°C		
	Humidity	10 ~ 85%RH(Non-condensing)		
	Vibration	10 ~ 25 Hz (X, Y, Z direction)2G/30minutes)		
CE Certification	CE Marked			
FCC Certification	FCC Class A			
Programming Software	PI Studio			
Remote Control	N/A			

PI3000i SPECIFICATIONS

Basic HMI



Model	PI3102i	PI3102i-2S	PI3102i-A
-------	---------	------------	-----------

Item	Specification		
CPU	CortexA7		
Touch Screen	Resistive		
Display	Screen Size	10.2inch	
	Resolution	1024*600	
	Brightness	350 cd/m ²	
	BacklightType	LED	
	BacklightLife	50,000 Hours	
Storage	Flash	128MB	
	RAM	128MB	
	SD Card	N/A	YES
	RTC	YES	
I/O Port	USB	USB Host: USB 2.0 x 1; USB Client: USB 2.0 x 1	
	Serial Port	RS232, RS422/RS485 (2 in 1)	COM1: RS232,RS422/RS485, CAN
			COM2: RS232,RS485
			COM3: RS485
	Ethernet	YES	
	CAN	N/A	YES
Permanent Calendar	Built-in		
Power	Power Supply	24V DC(12~28VDC)	
	Power Consumption	<10W	
Dimension	Enclosure	Plastic+ABS (Polycarbonate)	
	Dimension(mm)	272.0W * 191.0H * 41.5D	272.0W * 190.7H * 41.3D
	Mounting Size(mm)	260.0W * 179.0H	
	NetWeight(KG)	1.00	1.2
Environment	Protection	IP65 (Frontpanel)	
	Temperature	Storage: -20°C~70°C; Working: -10°C~55°C	
	Humidity	10 ~ 85%RH (Non-condensing)	
	Vibration	10 ~ 25 Hz (X, Y, Z direction)2G/30minutes)	
CE Certification	CE Marked		
FCC Certification	FCC Class A		
Programming Software	PI Studio		
RemoteControl	N/A		

LX5V Series PLC



LX5S Series PLC



8 Channel Pulse Input/Output

- 8 channels high speed counter ;
- 8 channels high speed pulse input, 150KHZ high-speed counter;
- 8 channels high speed pulse output, 200KHZ high-speed pulse output;
- Fast and accurate control.

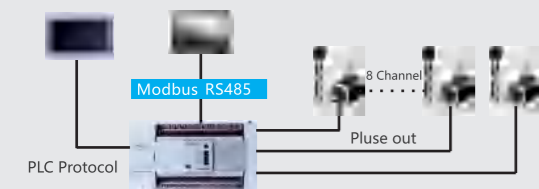

Easy Programming

- Friendly interface;
- Clear program classification;
- Detailed and clear parameter configuration.

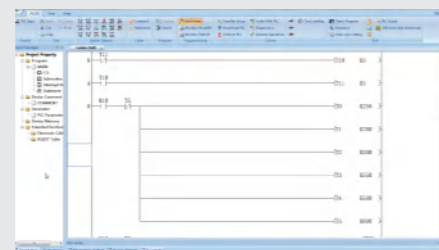

Functions

- Support to modify frequency and position during pulse running;
- Support the highest baud rate: 921600;
- Support 100us high-speed timer interrupt;
- Support up to 100 high-speed counter interrupts;
- Support E-CAM;
- Support electronic gear;
- Support efficient and stable PID and CCPID self-tuning;
- Support LX 3V series modules;
- USB power supply;
- LX5V Software;
- 0.03us~0.08us for basic instruction execution.

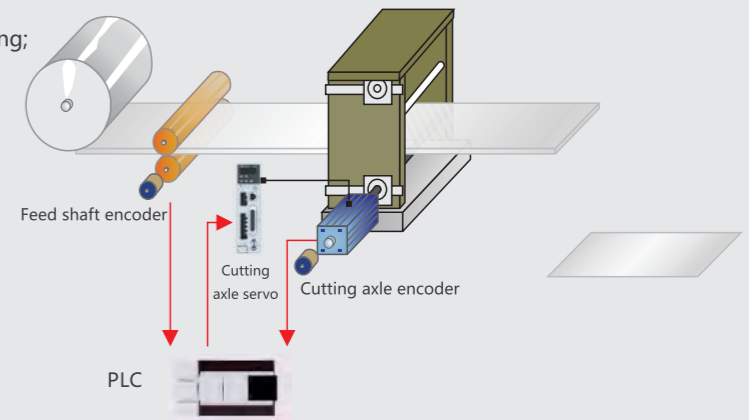

Fast

- 0.01us~0.03us for basic instruction execution ;
- Supports 8 channels external X interrupt;
- Support both rising edge and falling edge.

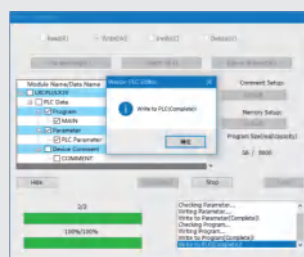

Functions

- Support to modify frequency and position during pulse running;
- Support the highest baud rate: 921600;
- Support 100us high-speed timer interrupt;
- Support up to 100 high-speed counter interrupt;
- Support E-CAM;
- Support electronic gear;
- Support efficient and stable PID and CCPID self-tuning;
- Support BD module of LX 3V series (3V Communication BD module not supported);
- USB power supply.

More Registers

- 512KB program capacity;
- 76KB latched capacity;
- 76KB register capacity;
- Added 128 timers of 0.1ms;
- Added 128 timers of 1ms.

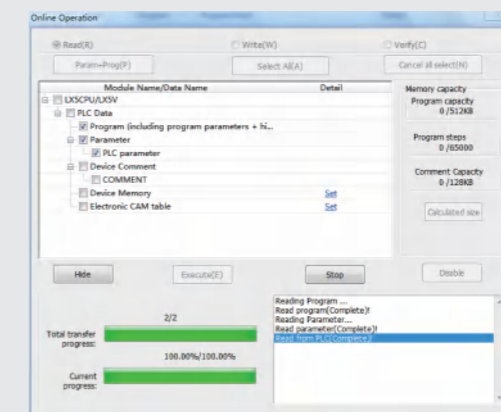

LX6V(6S) Series PLC

Modular EtherCAT PLC

Multi-port, fast communication, brand new product

- Supports EtherCAT and USB TYPE-C
- Supports 61131-3 LD programming mode, free tag protocol, faster and more efficient communication
- Nice appearance of PLC and module



LX6V/LX6S series PLC, small size and large capacity, a new evolution to bus PLC

Software upgrade

- Newly designed overall encryption scheme
- Newly designed free tag protocol
- Compatible with 5V 61131-3 LD program
- Custom FB/FC
- Global variable definition
- EtherCAT configuration
- EtherNet configuration

Capacity upgrade

- 5MB large program capacity
- 512KB latched capacity
- 100KB register capacity
- 5MB free tag capacity

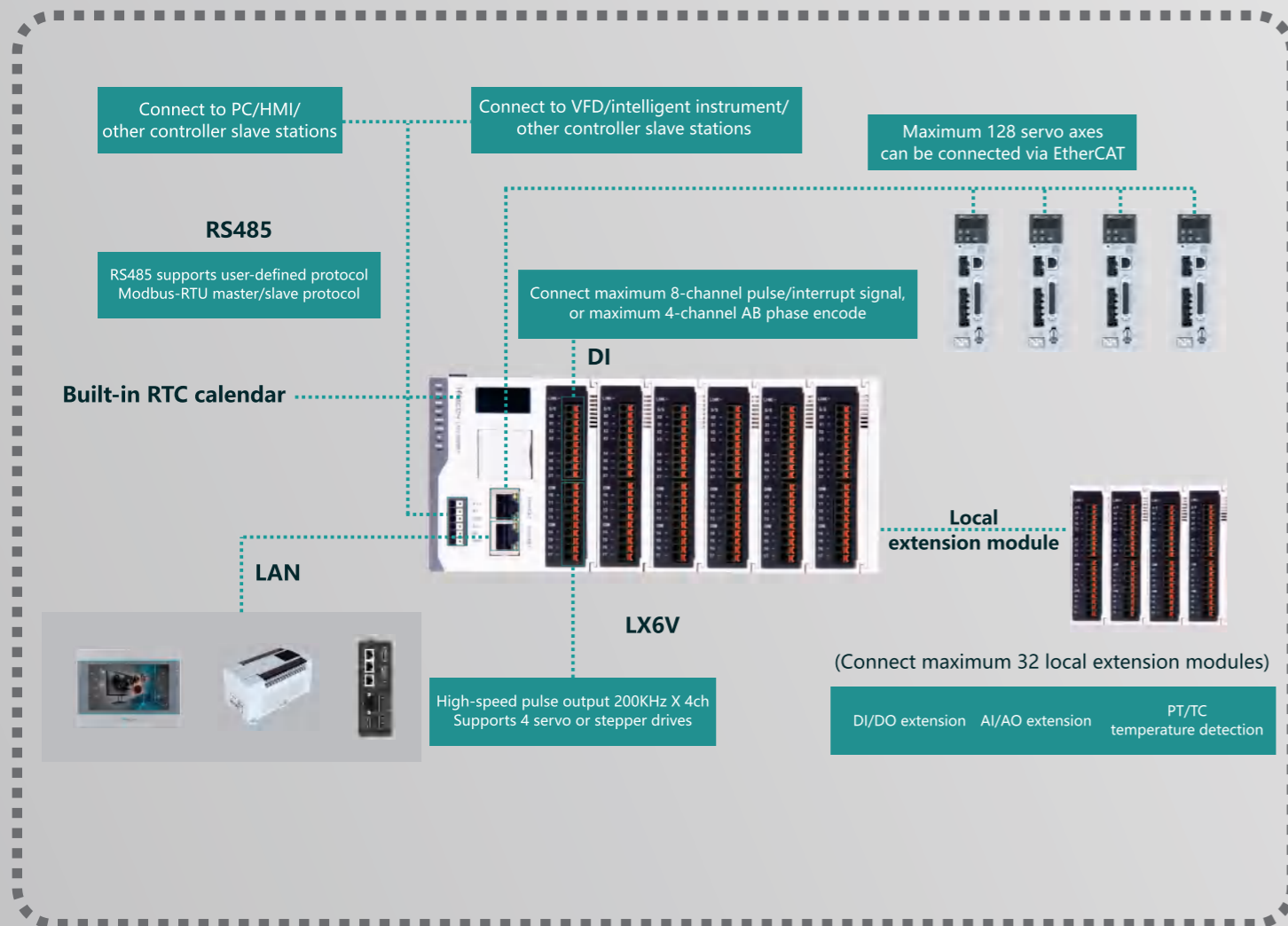
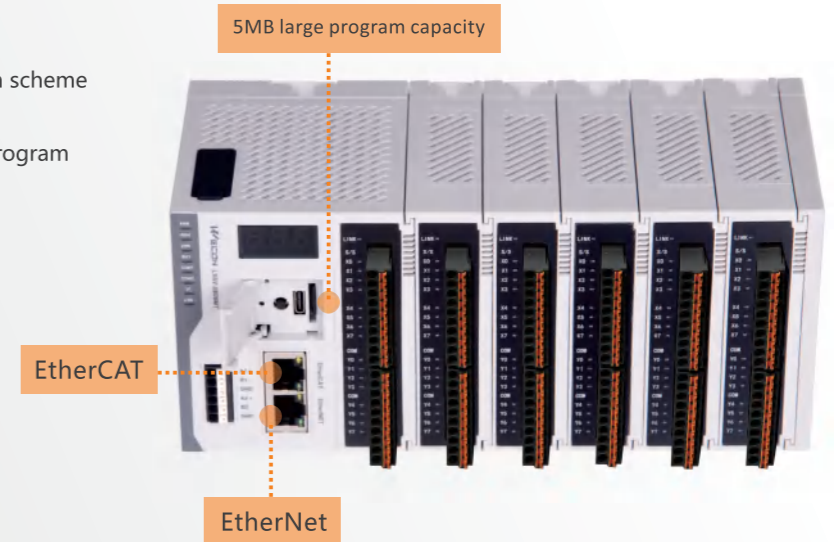

PLC General

Item	LX6V(LX6S) -0808MT/1616MT
Running Mode	Cycle Scan/ Interrupt
Programming	Instruction table/ladder diagram/FB/FC
Total Instructions	Basic instruction:29 / Application instruction: 170
Execute time	Basic instruction 0.01-0.02μs
System EMMC	5M
Download/Monitoring	Programming cable (Port)
	EtherNet
High Speed Pulse Output	Transistor type 4 channels 200KHz
High speed counter interrupt	100 channels
Timer Interrupt	100 channels, support 0.1ms interrupt
External input interrupt	X0-X7 supports both rising and falling edges
High Speed Input Single	8 channels 150 KHz
High Speed Input AB Phase	4 channels 150K Hz, supports 2 or 4 frequency multiplication
Power-down save	Adjusted by software
Storage	FLASH
Filter	For all the input terminals
Serial Port	RS485 , RS485
Temperature	Working Temperature: 0 ~ 55°C / Storage Temperature: -20 ~ 70°C
Humidity	35~85%RH (Without condensation)
Shock Resistance	JISC0040 Standard
Influence Immunity	Meet the IEC61000-4-4 and GB/T 17626.4 standard: Noise voltage amplitude 1KVP-P, pulse width 10us, period 0.3 s, edgetime 5ns, duration 1min.
TF	Support
ETHERNET	Megabit Ethernet(LX6S)/Gigabit Ethernet for LX6V
ETHERCAT	Up to 128 servo axis

LX6C Series PLC

LX6C
High-performance
Medium-size Controller

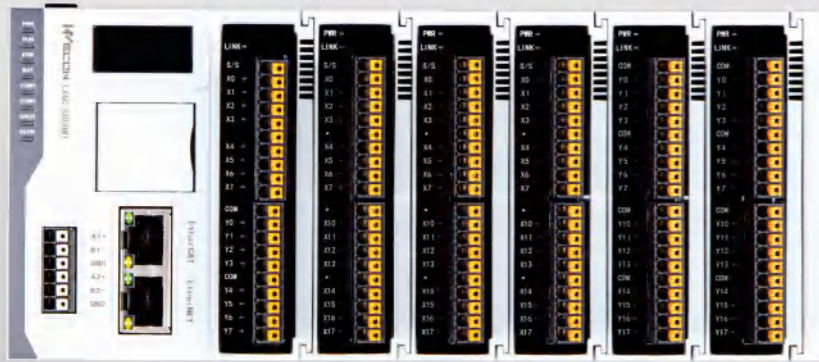

Based on
the **CODESYS** Platform

Program Execution

---SUPERIOR SPEED

4-core 1.8G CPU boosts instruction processing speed; NS-level basic instruction execution speed; Multitasking management system.

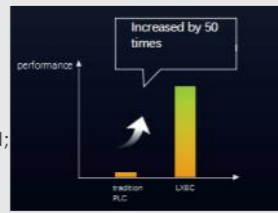

Expansion Module

---Scale at High Speed

High speed communication, quick response; Free optional, Flexible matching to meet needs; Blade structure, easy to install and save space.



Communication Protocol

---Seamless Connectivity

Standard with Ethernet, Multi-protocol link



Motion Control

---Ultimate Operation Control

Single-axis motion control; Multi-axis motion control; Buffer Mode; Movement superposition.



Project Development

---Rapid Development

Follow the PLCopen2.0 Standard, easy programming Program online monitoring, easy debugging User permissions management, project password.

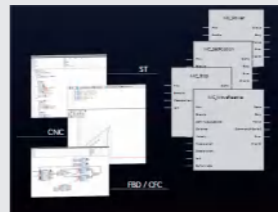

Operation & Maintenance

---Perfectly and Reliable

Easily remote debugging and upgrade in V-NET System

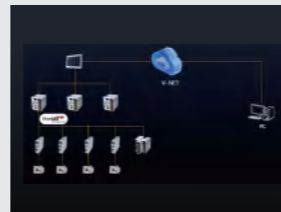

Specifications

Model	LX6C-0808MT/1616MT	
Program Space	ProgramCapacity	50MB
	VariableCapacity	10MB
	I Area (%)	128KB
	Q Area (%Q)	128KB
	M Area (%M)	512KB
	Power-down Latch Area	1MB
Programming Language		LD/IL/FBD/CFC/SFC/ST
EtherNet	Function	Communication, debugging, uploading and downloading programs, firmware upgrade, etc.
	Data Transmission	1000Mbps/100Mbps/10Mbps
	Total TCP Connections	Maximum 28
	ModbusTCP	Maximum 28
	Socket	Maximum 28
	Cable	Standard industrial Ethernet communication
EtherNet/IP	Server	Maximum connections: 128
	Client	Maximum connections: 128
EtherCAT	Transmission Speed	100Mbps (100Base-TX)
	Topology	Bus type
	Cable	Standard EtherCAT communication cable
	Maximum Transmission	100 meters
	Maximum Number from	256
	Maximum Process Data	1380 (maximum frame number is 1)
Communication Cycle	Minimum of 125µs It lasts for 1 minute.	
	Support Protocol	EtherCAT master
OPC-UA Server		Support
USB	Quantity	1 channel TYPE-C interface
	Function	RTC calibration, IP setting, firmware upgrade, etc.
	Specifications	USB 2.0
RS485	Quantity	2
	Baud Rate (bps)	1200, 2400, 4800, 9600, 19200, 38400, 57600, 115200
	Maximum	500m (9600 baud rate)
	Communication Mode	Half duplex
	Support Protocol	Modbus master/slave (RTU/ASCII), free communication protocol
	Topology	Bus type
Maximum Number of	31	
TF Card		Support
Power Supply		DC24V (±10%)
Motion Control	Support Version	PLC OPEN Motion Control 2.0
	CNC	Support
	G-code Capacity	32M
	Robotic (Axis Group)	Built-in 25 kinematic models, Maximum 8 axis groups (Maximum 6 axis interpolation per axis group)
EtherCAT Axis	Number of Servo Axis	128 axis (8 sets @ 500µs)
	Servo Axis	32
Expansion Module	Maximum Number	32
	Host IO	
	Input	8
	Output	8

LX6 & LX5 Series PLC Models

LX6V & LX6S & LX6C Model

LX6V PLC Model	I / O	Output Type	Dimension (mm)	Pulse Counter	E-CAM	Pulse Counter	RS485	EtherCAT	BD Board	Power Supply	Ethernet
LX6V-0808MT-DB	08/08	Transistor	85x90x110	4	YES	4	2	16 Axis	32	DC	Gigabit
LX6V-0808MT-DC	08/08	Transistor	85x90x110	4	YES	4	2	32 Axis	32	DC	Gigabit
LX6V-0808MT-DD	08/08	Transistor	85x90x110	4	YES	4	2	64 Axis	32	DC	Gigabit
LX6V-0808MT-DE	08/08	Transistor	85x90x110	4	YES	4	2	128 Axis	32	DC	Gigabit
LX6C-0808MT-DB	08/08	Transistor	85x90x110	-	YES	-	2	16 Axis	32	DC	Gigabit
LX6C-0808MT-DD	08/08	Transistor	85x90x110	-	YES	-	2	64 Axis	32	DC	Gigabit
LX6S-0808MT-DA	08/08	Transistor	85x90x110	4	YES	4	2	8 Axis	32	DC	Gigabit
LX6S-0808MT-DB	08/08	Transistor	85x90x110	4	YES	4	2	16 Axis	32	DC	Gigabit

LX5V PLC Model

LX5V Model	I/O	Output Type	Dimension (mm)	Pulse Counter	E-CAM	Pulse Output	RS485	BD Board	Module	Power Supply	Ethernet
LX5V-1412MT-A(D/AN/DN)	14/12	Transistor	137x107x87	4	YES	4	2	1	YES	AC(DC)	Optional
LX5V-1616MT-A(D/AN/DN)	16/16	Transistor	175x107x87	8	YES	8	2	2	YES	AC(DC)	Optional
LX5V-2416MT-A(D/AN/DN)	24/16	Transistor	175x107x87	8	YES	8	2	2	YES	AC(DC)	Optional
LX5V-2424MT-A(D/AN/DN)	24/24	Transistor	220x107x87	8	YES	8	2	2	YES	AC(DC)	Optional
LX5V-3624MT-A(D/AN/DN)	36/24	Transistor	220x107x87	8	YES	8	2	2	YES	AC(DC)	Optional

LX5S PLC Model

LX5S Model	I/O	Output Type	Dimension (mm)	Pulse Counter	E-CAM	Pulse Output	RS485	BD Board	Module	Power Supply	Ethernet
LX5S-0806MT-A(D)	08/06	Transistor	75x107x87	2	YES	2	1	1	N/A	AC(DC)	N/A
LX5S-0806MR-A(D)	08/06	Relay	75x107x87	2	N/A	0	1	1	N/A	AC(DC)	N/A
LX5S-0806MR2H-A(D)	08/06	Mix	75x107x87	2	YES	2	1	1	N/A	AC(DC)	N/A
LX5S-1208MT-A(D)	12/08	Transistor	75x107x87	2	YES	2	1	1	N/A	AC(DC)	N/A
LX5S-1208MR-A(D)	12/08	Relay	75x107x87	2	N/A	0	1	1	N/A	AC(DC)	N/A
LX5S-1208MR2H-A(D)	12/08	Mix	75x107x87	2	YES	2	1	1	N/A	AC(DC)	N/A
LX5S-1412MT-A(D/AN/DN)	14/12	Transistor	137x107x87	2	YES	2	2	1	YES	AC(DC)	Optional
LX5S-1412MR-A(D/AN/DN)	14/12	Relay	137x107x87	2	YES	2	2	1	YES	AC(DC)	Optional
LX5S-1412MR2H-A(D/AN/DN)	14/12	Mix	137x107x87	2	YES	2	2	1	YES	AC(DC)	Optional
LX5S-1616MT-A(D/AN/DN)	16/16	Transistor	175x107x87	6	YES	2	2	2	YES	AC(DC)	Optional
LX5S-1616MR-A(D/AN/DN)	16/16	Relay	175x107x87	6	N/A	0	2	2	YES	AC(DC)	Optional
LX5S-1616MR2H-A(D/AN/DN)	16/16	Mix	175x107x87	6	YES	2	2	2	YES	AC(DC)	Optional
LX5S-1616MT4H-A(D/AN/DN)	16/16	Transistor	175x107x87	6	YES	4	2	2	YES	AC(DC)	Optional
LX5S-2416MT-A(D/AN/DN)	24/16	Transistor	175x107x87	6	YES	2	2	2	YES	AC(DC)	Optional
LX5S-2416MR-A(D/AN/DN)	24/16	Relay	175x107x87	6	N/A	0	2	2	YES	AC(DC)	Optional
LX5S-2416MR2H-A(D/AN/DN)	24/16	Mix	175x107x87	6	YES	2	2	2	YES	AC(DC)	Optional
LX5S-2416MT4H-A(D/AN/DN)	24/16	Transistor	175x107x87	6	YES	4	2	2	YES	AC(DC)	Optional
LX5S-2424MT-A(D/AN/DN)	24/24	Transistor	220x107x87	6	YES	2	2	2	YES	AC(DC)	Optional
LX5S-2424MR-A(D/AN/DN)	24/24	Relay	220x107x87	6	YES	2	2	2	YES	AC(DC)	Optional
LX5S-2424MR2H-A(D/AN/DN)	24/24	Mix	220x107x87	6	YES	2	2	2	YES	AC(DC)	Optional
LX5S-2424MT4H-A(D/AN/DN)	24/24	Transistor	220x107x87	6	YES	4	2	2	YES	AC(DC)	Optional
LX5S-3624MT-A(D/AN/DN)	36/24	Transistor	220x107x87	6	YES	2	2	2	YES	AC(DC)	Optional
LX5S-3624MR-A(D/AN/DN)	36/24	Relay	220x107x87	6	N/A	0	2	2	YES	AC(DC)	Optional
LX5S-3624MR2H-A(D/AN/DN)	36/24	Mix	220x107x87	6	YES	2	2	2	YES	AC(DC)	Optional
LX5S-3624MT4H-A(D/AN/DN)	36/24	Transistor	220x107x87	6	YES	4	2	2	YES	AC(DC)	Optional

LX3V Series PLC Models

LX3V PLC Model

LX3V Model	I/O	Output Type	Dimension (mm)	Pulse Counter	Pulse Output	RS485	BD Board	Module	Power Supply
LX3V-0806MR-A1 (D1)	08/06	Relay	75x107x87	2	0	1	1	N/A	AC (DC)
LX3V-0806MT-A1 (D1)	08/06	Transistor	75x107x87	2	2	1	1	N/A	AC (DC)
LX3V-0806MR-A2 (D2)	08/06	Relay	75x107x87	2	0	1	1	N/A	AC (DC)
LX3V-0806MT-A2 (D2)	08/06	Transistor	75x107x87	2	2	1	1	N/A	AC (DC)

LX3V-1208MR-A1 (D1)	12/08	Relay	75x107x87	2	0	1	1	N/A	AC (DC)
LX3V-1208MT-A1 (D1)	12/08	Transistor	75x107x87	2	2	1	1	N/A	AC (DC)
LX3V-1208MR-A2 (D2)	12/08	Relay	75x107x87	2	0	1	1	N/A	AC (DC)
LX3V-1208MT-A2 (D2)	12/08	Transistor	75x107x87	2	2	1	1	N/A	AC (DC)
LX3V-1208MR2H--A2 (D2)	12/08	Mix	75x107x87	2	2	1	1	N/A	AC (DC)

LX3V-1412MR-A (D)	14/12	Relay	137x107x87	2	0	2	1	YES	AC (DC)
LX3V-1412MT-A (D)	14/12	Transistor	137x107x87	2	2	2	1	YES	AC (DC)
LX3V-1412MT4H-A (D)	14/12	Transistor	137x107x87	2	4	2	1	YES	AC (DC)
LX3V-1412MR2H-A (D)	14/12	Mix	137x107x87	2	2	2	1	YES	AC (DC)

LX3V-1616MR-A (D)	16 / 16	Relay	175x107x87	2	0	2	2	YES	AC (DC)
LX3V-1616MT-A (D)	16 / 16	Transistor	175x107x87	2	2	2	2	YES	AC (DC)
LX3V-1616MT4H-A (D)	16 / 16	Transistor	175x107x87	2	4	2	2	YES	AC (DC)
LX3V-1616MR2H-A (D)	16 / 16	Mix	175x107x87	2	2	2	2	YES	AC (DC)

LX3V-2416MR-A (D)	24 / 16	Relay	175x107x87	2	0	2	2	YES	AC (DC)
LX3V-2416MT-A (D)	24 / 16	Transistor	175x107x87	2	2	2	2	YES	AC (DC)
LX3V-2416MT4H-A (D)	24 / 16	Transistor	175x107x87	2	4	2	2	YES	AC (DC)
LX3V-2416MR2H-A (D)	24 / 16	Mix	175x107x87	2	2	2	2	YES	AC (DC)

LX3V-2424MR-A (D)	24/ 24	Relay	220x107x87	2	0	2	2	YES	AC (DC)
LX3V-2424MT-A (D)	24 / 24	Transistor	220x107x87	2	2	2	2	YES	AC (DC)
LX3V-2424MT4H-A (D)	24 / 24	Transistor	220x107x87	2	4	2	2	YES	AC (DC)
LX3V-2424MR2H-A (D)	24 / 24	Mix	220x107x87	2	2	2	2	YES	AC (DC)

LX3V-3624MR-A (D)	36 / 24	Relay	220x107x87	2	0	2	2	YES	AC (DC)
LX3V-3624MT-A (D)	36 / 24	Transistor	220x107x87	2	2	2	2	YES	AC (DC)
LX3V-3624MT4H-A (D)	36 / 24	Transistor	220x107x87	2	4	2	2	YES	AC (DC)
LX3V-3624MR2H-A (D)	36 / 24	Mix	220x107x87	2	2	2	2	YES	AC (DC)

LX3VP Series PLC Models

LX3VP PLC Model

PLC Model	I/O	Output type	Dimension (mm)	Pulse Counter	Pulse Output	RS485	CAN	BD Board	Module	Power Supply
LX3VP-1208MR-A(D)	12/8	Relay	75x107x87	2	0	1	N/A	1	N/A	AC (DC)
LX3VP-1208MT-A(D)	12/8	Transistor	75x107x87	2	2	1	N/A	1	N/A	AC (DC)
LX3VP-1212MR-A(D)	12/12	Relay	137x107x87	2	0	2	N/A	1	YES	AC (DC)
LX3VP-1212MT-A(D)	12/12	Transistor	137x107x87	2	2	2	N/A	1	YES	AC (DC)
LX3VP-1212MT4H-A(D)	12/12	Transistor	137x107x87	2	4	2	N/A	1	YES	AC (DC)
LX3VP-1212MR2H-A(D)	12/12	Mix	137x107x87	2	2	2	N/A	1	YES	AC (DC)

LX3VP-1412MR-A(D)	14/12	Relay	137x107x87	2	0	2	N/A	1	YES	AC (DC)
LX3VP-1412MT-A(D)	14/12	Transistor	137x107x87	2	2	2	N/A	1	YES	AC (DC)
LX3VP-1412MT4H-A(D)	14/12	Transistor	137x107x87	2	4	2	N/A	1	YES	AC (DC)
LX3VP-1412MR2H-A(D)	14/12	Mix	137x107x87	2	2	2	N/A	1	YES	AC (DC)

LX3VP-1616MR-A(D)	16/16	Relay	175x107x87	2	0	2	N/A	2	YES	AC (DC)
LX3VP-1616MT-A(D)	16/16	Transistor	175x107x87	2	2	2	N/A	2	YES	AC (DC)
LX3VP-1616MT4H-A(D)	16/16	Transistor	175x107x87	2	4	2	N/A	2	YES	AC (DC)
LX3VP-1616MR2H-A(D)	16/16	Mix	175x107x87	2	2	2	N/A	2	YES	AC (DC)

LX3VP-2416MR-A(D)	24/16	Relay	175x107x87	2	0	2	Optional	2	YES	AC (DC)
LX3VP-2416MT-A(D)	24/16	Transistor	175x107x87	2	2	2	Optional	2	YES	AC (DC)
LX3VP-2416MT4H-A(D)	24/16	Transistor	175x107x87	2	4	2	Optional	2	YES	AC (DC)
LX3VP-2416MR2H-A(D)	24/16	Mix	175x107x87	2	2	2	Optional	2	YES	AC (DC)

LX3VP-2424MR-A(D)	24/24	Relay	220x107x87	2	0	2	N/A	2	YES	AC (DC)
LX3VP-2424MT-A(D)	24/24	Transistor	220x107x87	2	2	2	N/A	2	YES	AC (DC)
LX3VP-2424MT4H-A(D)	24/24	Transistor	220x107x87	2	4	2	N/A	2	YES	AC (DC)
LX3VP-2424MR2H-A(D)	24/24	Mix	220x107x87	2	2	2	N/A	2	YES	AC (DC)

LX3VP-3624MR-A(D)	36/24	Relay	220x107x87	2	0	2	N/A	2	YES	AC (DC)
LX3VP-3624MT-A(D)	36/24	Transistor	220x107x87	2	2	2	N/A	2	YES	AC (DC)
LX3VP-3624MT4H-A(D)	36/24	Transistor	220x107x87	2	4	2	N/A	2	YES	AC (DC)
LX3VP-3624MR2H-A(D)	36/24	Mix	220x107x87	2	2	2	N/A	2	YES	AC (DC)

LX5V General Specifications

Item	LX5V-1212MT/1412MT	LX5V-1616MT/2416MT	LX5V-2424MT/3624MT
Running Mode	RoundScan/Interrupt		
Programming	Instruction List/ Ladder		
Total Instructions	Basic Instructions: 29 / Application Instruction: 170		
Execute time	Basic Instructions: 0.01-0.03µs		
System Flash	512KB/384KB(EthernetModel)		
Download/Monitoring	Serial Programming Cable(Serial Port) / Micro USB / Ethernet		
Ethernet	100MEthernet(Optional)		
High Speed Pulse Output	Transistor: 4 channels / 200KHz	Transistor: 8 channels / 200KHz	Transistor: 8 channels / 200KHz
High speed counter interrupt	100 channels		
Timer Interrupt	100Channels, Interruption time(min):0.1ms		
External input interrupt	X0-X7 supports both risingand falling edges		
High Speed Input Single	4 Channels 150KHz	8 Channels 150KHz	8 Channels 150KHz
High Speed Input AB Phase	4 channel100KHz, frequency modes:1/2/4times	8 channel100KHz, frequency modes:1/2/4 times	8 channel100KHz, frequency modes:1/2/4 times
Power-down save	Adjusted by software		
Filter	For all X input terminals		
Serial Port	COM1: RS422 /RS485 COM2: RS485		
Temperature	Working Temperature: 0 ~ 55°C /Storage Temperature 0 ~ 70°C		
Humidity	35~85%RH (No condensation)		
Shock Resistance	JISC0040 Standard		
Influence Immunity	MeettheIEC61000-4-4and GB/T 17626.4 standard: Noise voltage amplitude 1KVP-P , pulsewidth 10us, period 0.3 s, edgetime 5ns , duration 1min.		
USB Supply	Use for upgrading firmware, downloading ladder diagram	N/A	Use for upgrading firmware, downloading ladder diagram

LX5S General Specifications

Item	LX5S-0806MT/MR LX5S-1208MT/MR	LX5S-1212MT/MR LX5S-1412MT/MR	LX5S-1616MT/MR LX5S-2416MT/MR	LX5S-2424MT/MR LX5S-3624MT/MR
Running Mode	Round Scan/ Interrupt / Event			
Programming	Instruction table/ladder diagram			
Total Instructions	Basic instruction: 29 / Application instruction: 170			
Execute time	Basic instruction 0.03-0.008 μs			
System EMMC	512KB			
Download/Monitoring	Programming cable (serial type)/ MicroUSB / Ethernet			
Ethernet	N/A	100M Ethernet(Optional)		
High Speed Pulse Output	Transistor type; 2 channels/ 200KHz			
High speed counter interrupt	100 channel			
Timer Interrupt	100 channels, support 0.1ms interrupt			
External input interrupt	X0-X5 supports both rising and falling edges			
High Speed Input Single Phase	2 channel 150K Hz; 4 channel 10KHz	2 channel 150K Hz; 4 channel 10KHz	6 channel 150K Hz	6 channel 150KHz
HighSpeed Input AB Phase	1 channel 100K Hz, supports 2 or 4 frequency multiplication 2 channels 10K Hz, supports 2 or 4 frequency multiplication	1 channel 100K Hz, supports 2 or 4 frequency multiplication 2 channels 10K Hz, supports 2 or 4 frequency	3 channels 100K Hz, supports 2 or 4 frequency multiplication	3 channels 100K Hz, supports 2 or 4 frequency multiplication
Power-down save	Adjusted by software			
Filter	For all X input terminals			
Serial Port	COM1 (RS422), COM2 (RS485)	COM1 (RS422 / RS485) , COM2 (RS485)		
Temperature	Working Temperature : 0 ~ 55°C / Storage Temperature: 0 ~ 70°C			
Humidity	35~85%RH (Without condensation)			
Shock Resistance	JISC0040 Standard			
Influence Immunity	Meet the IEC61000-4-4 and GB/T 17626.4 standard: Noise voltage amplitude 1KVP-P , pulse width 10us, period 0.3s, edge time 5ns , duration 1min.			
USB Supply	YES			

Output

Item	Relay Output	Transistor Output
Output Mode	--	NPN
Input Power Supply	DC 24V	DC 24V
Output Circuit	<AC 250V or <DC 30V	DC 5~30V
COM Port Current	--	<0.1mA (DC 30V)
Insulation	Mechanistic	Optical Coupling
Leak Current	--	0.1mA /DC 30V
Minimum Load	--	DC 5V 2mA
Maximum Output Current	Resistive load	0.5A/output terminal 0.8A/COM terminal 0.3A/High speed output terminal
	Inductive load	80VA
	Lamp load	100W
Response Time	ON	<0.2ms
	OFF	<10ms (High speed output terminal: <5us)

PLC General Specifications

	LX3V Series	LX3VP Series
Running Mode	Round Scan/ Interrupt	
Programming	Instruction List/Ladder	
Total Instructions	Basic Instructions: 27 / Application Instruction: 138	Application Instruction: 140
Execute time	Basic Instructions: 0.06us / Application Instruction: 1~10us	
System Flash	16K	64K
Download/Monitoring	Serial Programming Cable (Serial Port) / Micro USB	
High Speed Pulse Output	Transistor: 2 channels (4 channel optional) / Relay N/A (2 channel optional)	
External Interrupt	6 Channels	
Timer Interrupt	3 Channels	
High Speed Input Single Phase	2 channels 200KHz, 4 channels 5KHz	
High Speed Input AB Phase	1 channel 100KHz, frequency modes: 1/2/4 times; 1 channel 5KHz, frequency modes: 1/2/4 times	
Holding Addresses	Adjustable	
Filter	For all X input terminals	
Serial Port	COM1: RS422 or RS485 COM2: RS485	
Temperature	Working Temperature: 0 ~ 55°C / Storage Temperature: -20 ~ 70°C	
Humidity	5~85%RH (Without condensation)	
Shock Resistance	JISC0040 Standard	
Influence Immunity	Meet the IEC61000-4-4 and GB/T 17626.4 standard: Noise voltage amplitude 1KVP-P , pulse width 10us, period 0.3s, edge time 5ns , duration 1min.	

AC Power Supply

Item	≤ 26 I/O	≥ 26 I/O
Power Supply	LX3V Series: AC85~264V 50~60Hz; LX5V/S Series: AC85~265V 50~60Hz	
Power Outage Time	10ms	
Rush Current	<15A 5ms / AC 100V; <30A 5ms / AC 200V	
Power Fuse	250V 3.15A	
Power Consumption	<35W	<60W
Power Output	DC 24V 700mA	

DC Power Supply

Item	LX3V / LX3VP / LX5V / LX5S PLC	LX6V PLC
Power Supply	DC 24V ±10%	
Power Outage Time	10ms	
Power Fuse	250V 3.15A	
Rush Current	<15A 1ms / DC 24V	<45A 1ms / DC 24V
Power Consumption	<30W (Not include the external power supply for modules)	<12W (Not include the external power supply for modules)

LX6V Coupler

LX6V-EM□-ECAT Remote I/O coupler

Based on EtherCAT bus technology
Diversified module types that are faster, more stable and more convenient.
Easily meet various system configurations

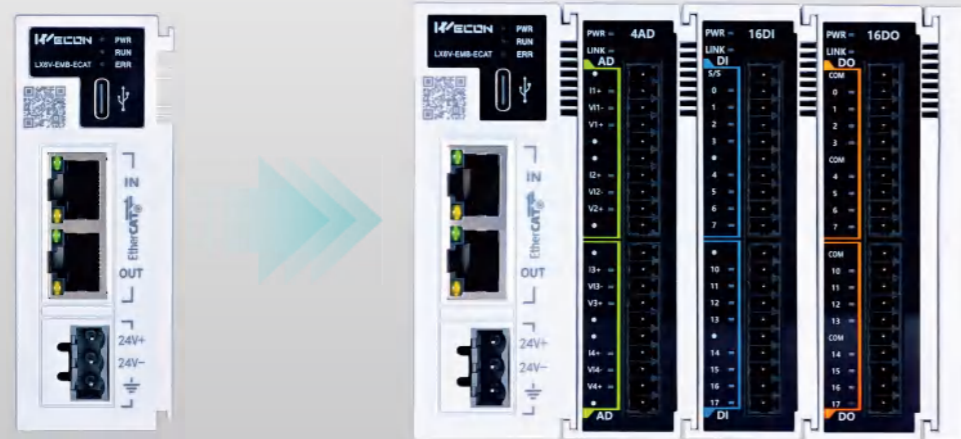

Flexible configuration and more expansion

- Support up to 32 expansion modules;
- The I/O configuration can be adjusted through the software, meeting the various requirements of different cases.

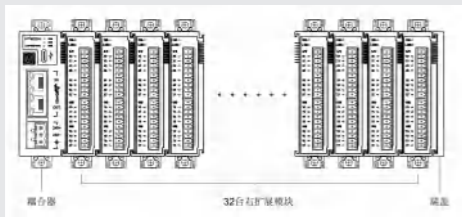

More precision and efficiency

- EtherCAT distributed I/O separates controllers and devices to achieve truly distributed control;
- At the same time, the communication delay between devices is reduced, and the speed and accuracy of data acquisition are improved.

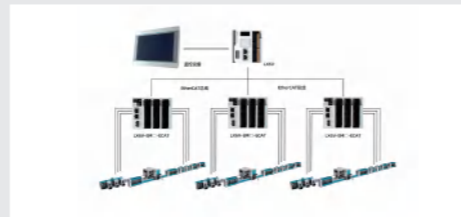

Easy installation

- Tool-free blade mounting;
- Compact structure is more stable;
- Small size and space-saving.



Superior performance

- High-speed bus microsecond response, speed up to 100Mbps;
- Support a large number of I/O node connections to meet high-speed data acquisition and precise control.



Coupler

Universal Type



Model	LX6V-EMB-ECAT	LX6V-EMC-ECAT
Item	Specification parameter	
Maximum expansion module	16	32
Rated input voltage	DV 24V±10%, 100mA (without expansion module)	
Communication interface	RJ45×2, EtherCAT communication protocol with 100Mbps performance; EtherCAT IN: EtherCAT input port; EtherCAT OUT: EtherCAT output port.	
Transmission distance	Length of communication line between two nodes≤100m	
Transmission medium	Category 5E (cat 5e) cable or above	
Single AP process data	Maximum input and output 1024 bytes	
Synchronous	Minimum 125us	
Allowable instantaneous power-off time	10ms	
Impulse current	≤45A (loaded with maximum module)	
Power protection	Anti-reverse connection protection; overcurrent protection; surge absorption	
Firmware upgrade	Support	
Usage environment	No corrosive, combustible gas, no large amount of conductive dust (dust)	
Environment temperature	Operating temperature: -20℃ to 55℃ Storage temperature: -40℃ to 70℃	
Environment humidity	Working humidity: 10% to 90%RH (No condensation) Storage humidity: ≤90%RH (No condensation)	
Altitude	0-2000m	
Installation	Installed on DIN46277 (Width: 35mm) rail by fastener	
Overall size	91.0*34.0*94.8mm	
Available module type	LX6 series expansion module	

Expansion Modules & BD Modules

LX3 Expansion Modules

LX3V Module		Specification	LX3V Module		Specification
I/O	LX3V-8EX/16EX	8 / 16 * Input	Temperature	LX3V-4PT	4 * Thermal Resistance Input
	LX3V-8EYR/16EYR	8 / 16 * Relay Output		LX3V-4TC	4 * Thermocouple Input
	LX3V-8EYT/16EYT	8 / 16 * Transistor Output		LX3V-4LTC	4 * TC with Isolation (PID Control)
Analog	LX3V-4AD	4 * Analog Input		LX3V-8iTC	8 thermocouple temperature module
	LX3V-4DA	4 * Analog Output	High Speed Pulse Output	LX3V-4PGA	Supports 4*200kHz high-speed pulse output. Supports T, S curve acceleration and deceleration.
Weighting	LX3V-1WT	1 * Weighting (24-bit)			Supports two-speed positioning and interrupt one-speed positioning. Supports variable speed operation. Supports single-speed positioning.
	LX3V-2WT	2 * Weighting (24-bit)		LX3V-4PGB	Supports 4*200kHz high-speed pulse output. Supports T curve acceleration and deceleration. Supports single-speed positioning.
	LX3V-1WT-L	1 * Weighting (18-bit)			
LX3V-2WT-L	2 * Weighting (18-bit)				

LX6 Expansion Modules

LX6 series expansion module		Specification	LX6 series expansion module		LX6 series expansion module
I/O	LX6V-16EX/32EX	16/32 * Input	Analog	LX6V-4AD	4 * Analog Input
	LX6V-16EYT/32EYT	16 /32 * Transistor Output (NPN)		LX6V-4DA	4 * Analog Output
	LX6V-16EYP/32EYP	16 /32 * Transistor Output (PNP)	Weighting	LX6V-1WT	1 * Weighting
	LX6V-0808EXYT	8 * Input, 8 * Transistor Output (NPN)		LX6V-2WT	2 * Weighting
	LX6V-0808EXYP	8 * Input, 8 * Transistor Output (PNP)	Temperature	LX6V-4TC	4 * Thermocouple Input
	LX6V-1616EXYT	16 * Input, 16 * Transistor Output (NPN)		LX6V-4PT	4 * PT100 Input
	LX6V-1616EXYP	16 * Input, 16 * Transistor Output (PNP)	Remote	LX6V-EMB-ECAT	EtherCAT coupler (support 16 * 6V module)
	LX6V-8HC	8 encoder input		LX6V-EMC-ECAT	EtherCAT coupler (support 32 * 6V module)
High Speed Pulse Output	LX6V-4PG	4 pulse expansion (Supports 4*200kHz high-speed pulse output.)			

LCM Expansion Modules

LCM Module		Specification	LCM Module		Specification
Remote	LCM-16EX	16 * Input, supports RS485 Modbus communication	Remote	LCM-2WT	2 * weighing expansion module, 24-bit resolution, supports RS485 Modbus communication.
	LCM-16EYR	16 * Relay Output, supports RS485 Modbus communication		LCM-4TC	4 * thermocouple Input, supports RS485 Modbus communication.

BD Modules

LX5V BD Modules

Except for Communication BD Modules, LX5V BD Modules can compatible with all LX3V PLC.

BD Module	Function	BD Module	Function
LX5V-8BYT-BD	8* DO Output (Transistor NPN output)	LX5V-2RS485-BD	2 * RS485 Communication
LX5V-8BX-BD	8* DI Input	LX5V-ETH-BD	1 * Ethernet Communication
LX5V-2ADV-BD	2*Analog Voltage Input(-10v-10v)	LX5V-4ADV-BD	4* Analog Input(-10V~10V)
LX5V-2ADI-BD	2*Analog Current Input(4-20mA)	LX5V-4ADI-BD	4 * Analog Input(4~20mA)
LX5V-2DAV-BD	2*Analog Voltage Output(-10v-10v)	LX5V-2ADV2DAV-BD	2 * Analog Input/ Output(-10V~10V)
LX5V-2DAI-BD	2*Analog Current Output(4-20mA)	LX5V-2ADI2DAI	2 * Analog Input/Analog Output(4~20mA)
LX5V-2PT-BD	2 * Thermal Resistance Input, Precision=0.2~0.3°C	LX5V-2PT2ADV-BD	2 * Thermal Resistance Input; 2 * Analog Voltage Input(-10v-10v)
LX5V-2PTS-BD	2* Thermal Resistance Input, Precision=0.1°C	LX5V-2PT2DAI-BD	2 * Thermal Resistance Input; 2 * Analog Output(4~20mA)
LX5V-2TC-BD	2 * Thermocouple Input (K Type, J Type)	LX5V-2PT2DAV-BD	2 * Thermal Resistance Input; 2 * Analog Voltage Output(-10v-10v)
LX5V-2TC2DAI-BD	2 * Thermocouple Input (K Type, J Type); 2 * Analog Output(4~20mA)		

28/54

WECON PLC

LX3V BD Modules

BD Module	Function	BD Module	Function
LX3V-2ADI2DAI-BD	2 * Analog Input/Analog Output(4~20mA)	LX3V-2PT-BD	2 * Thermal Resistance Input
LX3V-2TC2DAI-BD	2 * Thermocouple Input; 2 * Analog Output(4~20mA)	LX3V-2PT2ADV-BD	2 * Thermal Resistance Input; 2 * Analog Voltageinput(-10V-10V)
LX3V-2PT2DAI-BD	2 * Thermal Resistance Input; 2 * Analog Output(4~20mA)	LX3V-2PT2DAV-BD	2 * Thermal Resistancen lput 2 * Analog Voltage Output(-10V-10V)
LX3V-2TC-BD	2 * Thermocouple Input	LX3V-2ADV2DAV-BD	2 * AnalogInput/Output(-10V~10V)
LX3V-4ADI-BD	4 * Analog Input(4~20mA)	LX3V-2RS485-BD	2 * RS485 Communication
LX3V-4ADV-BD	4* Analog Input(-10V~10V)	LX3VP-ETH-BD	1 * Ethernet Communication
LX3V-2ADV-BD	2*Analog Voltage Input(-10V-10V)	LX3V-2DAI-BD	2*Analog Current Output(4-20mA)
LX3V-2ADI-BD	2*Analog Current Input(4-20mA)	LX3V-2DAV-BD	2*Analog Voltage Output(-10V-10V)
LX3V-2PTS-BD	2* Thermal Resistance Input, Precision >0.1°C		

WECON Servo Drives

VD3E EtherCAT Servo

Design for High Load Environment

- 125µs sync period
- <1µs sync jitter



High Response

High performance CPU
Faster data reading
Faster calculation and sampling speed

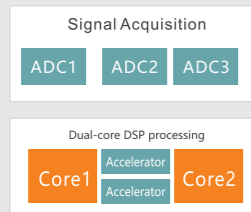

Easy to Debug

Automatic load parameter tuning function

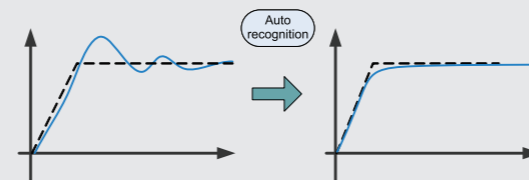

Strong Protection

Coating protection, anti-corrosion.
Rich protection functions, more stable.



Personalise

Virtual DI/DO function, four-channel real-time oscilloscope.



Support internal multi-speed instruction

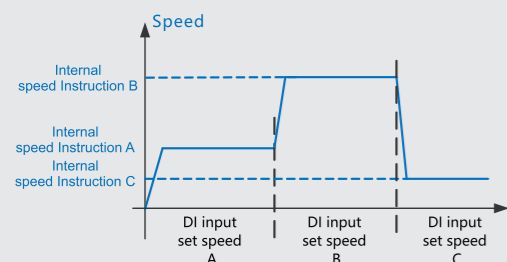

Support internal multi-segment position instruction

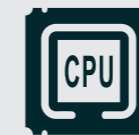
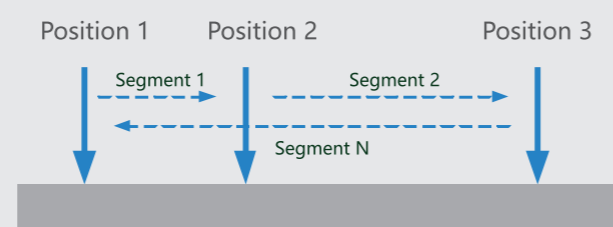

High Performance CPU

Multi-core Architecture
Communication & Control Parallel Processing
Higher Response
Stronger Performance



EtherCAT High-speed Bus Control

High Synchronization
Flexible Communication Connection
Flexible Networking



Rich Features

Parameter Self-tuning
Parameter Import and Export
Wave form Viewing and Storage
Vibration Suppression
Support Brake

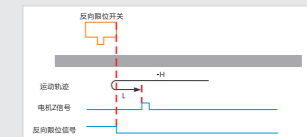

multi-mode control

Homing Mode(HM)
Cyclic Synchronous Position Mode (CSP)

SERVO Naming Rules

Drive Naming Rules

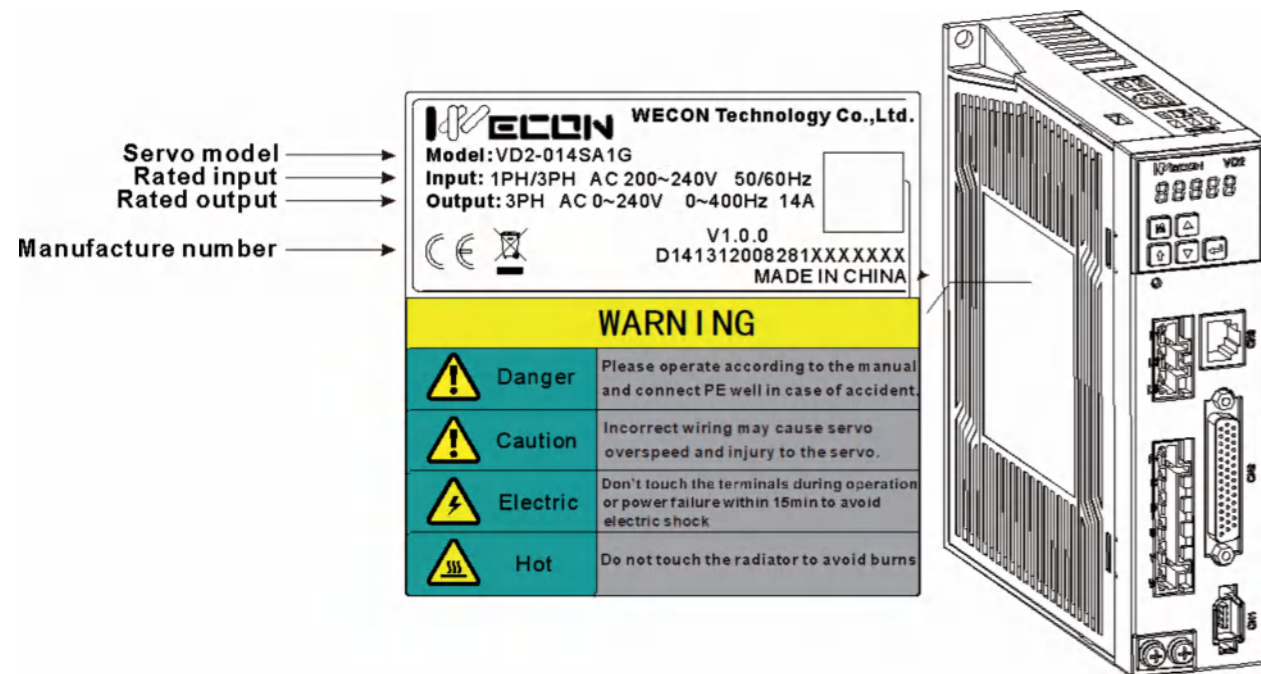
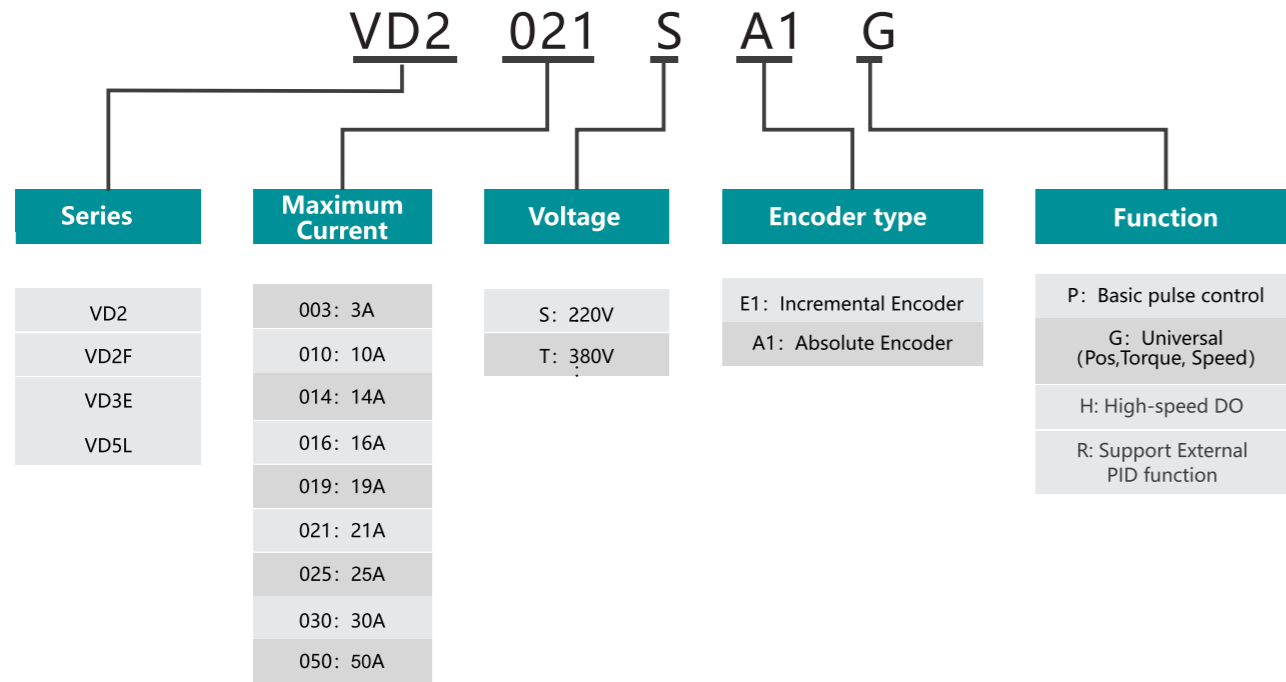

Servo Drive Matching Table

Servo Drives

Control type	Voltage level	Drive series	Drive model	Support motor	
Pulse type	220V	VD2F	VD2F-003SA1P	(0.1-0.2)kW	
			VD2F-010SA1P	(0.2-0.4)kW	
			VD2F-014SA1P	(0.6-0.75)kW (0.85-1.0)kW	
		VD2L	VD2L-010SA1P	(0.2-0.4)kW	
			VD2L-014SA1P/D	(0.6-0.75)kW (0.85-1.0)kW	
		VD2 Type A	VD2-010SA1G/R/H	(0.2-0.4)kW	
			VD2-014SA1G/R/H	(0.6-0.75)kW (0.85-1.0)kW	
			VD2-016SA1G/R/H	(0.85-1.5)kW	
		VD2 Type B	VD2-019SA1G/R/H	(1.5-2.0)kW	
	VD2-021SA1G/R/H		(2.0-2.5)kW		
	VD2-025SA1G		(2.5-3.0)kW		
	VD2-030SA1G		(3.0-4.0)kW		
	VD2-016TA1G		(0.85-1.5)kW		
	VD2-019TA1G		(1.5-2.0)kW		
	380V	VD2-021TA1G	(2.0-3.0)kW		
		VD2 Type C	VD2-030TA1G	(3.0-5.0)kW	
			VD2-040TA1G	(5.0-6.0)kW	
		VD2-050TA1G	(7.5)kW		
EtherCAT type		220V	VD3E Type A	VD3E-003SA1G	(0.1-0.2)kW
				VD3E-010SA1G	(0.2-0.4)kW
	VD3E-014SA1G			(0.6-0.75)kW (0.85-1.0)kW	
	VD3E Type B		VD3E-016SA1G	(0.85-1.5)kW	
			VD3E-019SA1G	(1.5-2.0)kW	
			VD3E-021SA1G	(2.0-2.5)kW	
	380V	VD3E Type B	VD3E-025SA1G	(2.5-3.0)kW	
			VD3E-030SA1G	(3.0-4.0)kW	
			VD3E-016TA1G	(0.85-1.5)kW	
	VD3E Type C	VD3E-019TA1G	(1.5-2.0)kW		
		VD3E-021TA1G	(2.0-3.0)kW		
		VD3E-030TA1G	(3.0-5.0)kW		
		VD3E-040TA1G	(5.0-6.0)kW		
		VD3E-050TA1G	(7.5)kW		

VD3E Drive Specifications

EtherCAT Type



Model	VD3E(A)	VD3E(B)	VD3E (C)
-------	---------	---------	----------

Item		VD3E (A)	VD3E (B)	VD3E (C)
Basic Specifications	Power Supply	220V		220V/380V
	Control Method	IGBT PWM control sine wave current drive		
	Encoder	17bit, 23bit absolute encoder		
	Input Signal	6 DI inputs,select the input function according to the function code configuration		
	Output Signal	3 DO outputs,select the output function according to the function code configuration		
	Host Communication	USB interface.Function code parameter setting,status monitoring,waveform viewing, parameter self-tuning,etc.can be performed through upper computer		
	Braking Resistor	Built-in braking resistor,support external braking resistor		
General Function	Automatic Parameter Tuning	Automatic load inertia identification, automatic rigidity level and parameter self-tuning can be carried out through the cooperation of the upper computer		
	Waveform Monitoring	The waveform of data such as real-time speed/torque/position deviation can be observed through the host		
	Waveform Storage	computer The waveform acquisition frequency is 1KHz,and the original waveform data can be saved up to 10s		
	Parameter import and Export	Support batch parameter import and export;support SDO download		
	Vibration Suppression	Mechanical vibration can be suppressed by setting vibration suppression parameters		
	Protective Function	Overvoltage,undervoltage,overcurrent,overspeed,overload,overheating,encoder failure,excessive position deviation,torque limit,speed limit,etc.		
	Brake	Support output control		
	Universal Control DI	Servo enable(SON), fault and warning clear (A-CLR), forward drive prohibition(POT), reverse drive prohibition (NOT), emergency stop(E-STOP)		
	Universal Control DO	servo ready(RDY), fault signal(ALM), warning signal(WARN), rotation detection(TGON), zero speed signal(ZSP), torque limit(T-LIMIT), speed limit(V-LIMIT), servo open state output(SRV-ST), servo brake output(BRK-OFF), communication VDO		
	Communication Protocol	EtherCAT protocol		
Support Service	CoE (PDO, SDO)			
Synchronously	DC-distributed clock			
physical Layer	100BASE-TX			
Baud Rate	100 Mbit/s(100Base-TX)			
Duplex Mode	Full Duplex			
Topology	Circular, Linear			
Transmission Medium	Shielded Cat 5e or better network cable.			
Transmission Distance	The distance between two nodes is less than 100M (the environment is good and the cable is good).			
Frame Length	44 bytes~1498 bytes			
Process Data	A single Ethernet frame is up to 1486 bytes.			
Sync Jitter	<1us			
Distributed Clock	64 bit			
EEPROM Capacity	8kbit initialization data is written by the EtherCAT master station			
Control Mode	CSP、HM			
Sync Cycle	125μs			

VD2 Drive Specifications

Universal Type



Model	VD2(A)	VD2(B)	VD2(C)
-------	--------	--------	--------

Item		VD2 (A)	VD2 (B)	VD2 (C)
Basic Specifications	Power Supply	220V	220V/380V	380V
	Control Method	IGBT PWM controlled sine wave current drive		
	Encoder	2500ppr incremental encoder;17 bit,23 bit absolute encoder		
	Input Signal	8*DI		
	Output Signal	4*DO		
	Analog Signal Input	2*AI input(-10v~10v)		
	Pulse Signal Input	Open collector or differential input		
	Pulse Feedback Output	A,B,Z differential output		
	Internal Instructions	Support 8 internal speed commands and internal multi-segment position commands		
	Communication/Debug	Support to communicate with modbus device and debug with SCTools at the same time. (SCTools can set&monitor servo parameters,monitor waveform,self-tuning parameter,etc.)		
General Function	Braking Resistor	400W without built-in braking resistor;both support external braking resistor		
	Self-tuning	SCTools supports self-tuning function,and identifies load inertia identification and rigidity level, and other parameters.		
	Waveform Monitoring	View position,speed, torque and other curves on PC in real time		
	Waveform Storage	The original waveform data could be stored for up to 10s		
	Parameter Import/Export	Support batch parameter import and export; support PLC configurate servo parameters automatically (supported by some models)		
	Vibration Suppression	Suppress mechanical vibration by setting vibration suppression parameters		
	Protective Function	Overvoltage,undervoltage,overcurrent,overspeed,overload,overheating,encoder failure,excessive position deviation,torque limit,speed limit,etc		
	Brake	Support		
	Universal Control DI	Servo enable(SON), fault and warning clear (A-CLR), forward drive prohibition(POT), reverse drive prohibition (NOT), command reverse (C-SIGN), emergency stop (E-STOP), Gainswitching (GAIN-SEL), Multi-speed command selection(INSPD1、INSPD2、INSPD3)Internal multi-position command selection and enable (POS1,POS2、POS3,POS4、POSEN)		
	Universal Control DO	Servo ready(RDY), fault signal(ALM), warning signal(WARN), rotation detection(TGON), zero speed signal(ZSP), torque limit(T-LIMIT), speed limit(V-LIMIT),servoon state output(SRV-ST), servo brake output(BRK-OFF)		
Function Setting	Pulse Frequency	Maximum 500khz		
	Pulse Type	Pulse + Direction,CCW/CW pulse, Quadraturel encoding		
	Pulse Filtering	First-order low-pass filter or smooth filter		
	Pulse Output	Differential Quadraturel encoding A, B, Z output;PPR is settable by p0-16or P0-17~P0-20.		
	Command Input	-10V~+10V analog input internal speed command(Maximum 8)		
	Zero Clamp	Motor speed could be clamped to zero via the setting of zero clamp function		
	Torque Limit	Support to set the torque limit		
	Command Input	-10V~+10V analog input and Internal torque command		
	Torque Reaching	Torque reaching threshold and DO can be set flexibly		
	Speed Limit	The speed limit can be set flexibly		

VD2F Drive Specifications

Universal Type



Model

VD2F

Item		VD2F Series
Basic Specifications	Power Supply	220V
	Control Method	IGBT PWM controlled sine wave current drive
	Encoder	17 bit, 23 bit absolute encoder
	Input Signal	4*DI
	Output Signal	4*DO
	Analog Signal Input	—
	Pulse Signal Input	Open collector or differential input
	Pulse Feedback Output	Z signal open collector output
	Internal Instructions	Support 8 internal speed commands and internal multi-segment position commands
	Communication/Debug	Support to communicate with modbus device or debug with SCTools
Braking Resistor		750W built-in braking resistor; 400W without built-in braking resistor; both support external braking resistor
General Function	Self-tuning	SCTools supports self-tuning function, and identifies load inertia identification and rigidity level, and other parameters.
	Waveform Monitoring	View position, speed, torque and other curves on PC in real time
	Waveform Storage	The original waveform data could be stored for up to 10s
	Parameter Import/Export	Support batch parameter import and export; support PLC configurate servo parameters automatically (supported by some models)
	Vibration Suppression	Suppress mechanical vibration by setting vibration suppression parameters
	Protective Function	Overvoltage, undervoltage, overcurrent, overspeed, overload, overheating, encoder failure, excessive position deviation, torque limit, speed limit, etc
	Brake	Support
	Universal Control DI	Servo enable (SON), fault and warning clear (A-CLR), forward drive prohibition (POT), reverse drive prohibition (NOT), command reverse (C-SIGN), emergency stop (E-STOP), Gain switching (GAIN-SEL), Multi-speed command selection (INSPD1, INSPD2, INSPD3); Internal multi-position command selection and enable (POS1, POS2, POS3, POS4, POSEN)
	Universal Control DO	Servo ready (RDY), fault signal (ALM), warning signal (WARN), rotation detection (TGON), zero speed signal (ZSP), torque limit (T-LIMIT), speed limit (V-LIMIT), servo on state output (SRV-ST), servo brake output (BRK-OFF); Z signal input
	Pulse Input	Pulse Frequency
Pulse Type		Pulse + Direction, Orthogonal coding
Pulse Filtering		First-order low-pass filter or smooth filter
Pulse Output		—
Speed Mode	Command Input	Only internal speed command is supported (Maximum 8)
	Zero Clamp	Motor speed could be clamped to zero via the setting of zero clamp function
	Torque Limit	Support to set the torque limit
Torque Mode	Command Input	Only internal torque command is supported
	Torque Reaching	Torque reaching threshold and DO can be set flexibly
	Speed Limit	The speed limit can be set flexibly

Motor Naming Rules

Series	Flange Size	Motor Inertia	Rated Power	Rated Speed	Voltage	Encoder Type	Motor Structure
WD:5-pole	40mm	L: Low inertia	010: 100W	15: 1500rpm	S: 220V	E1: 2500 Lines incremental optical encoder	F: Oil sealed
WE:4-pole	60mm	M: Medium inertia	020: 200W	20: 2000rpm	T: 380V	A1: 17 bit single Magnetic encoder C1: 17bit Multi Magnetic encoder D2: 23bit Multi Optical encoder	G: Oil sealed+Brake B: Oil sealed C: Oil sealed+Brake
	80mm	H: High inertia	040: 400W	25: 2500rpm			
	110mm		073: 730W	30: 3000rpm			
	130mm		075: 750W				
	180mm		100: 1KW				
			110: 1.1KW				
		120: 1.2KW					
		150: 1.5KW					
		180: 1.8KW					
		200: 2.0KW					
		230: 2.3KW					
		260: 2.6KW					
		750: 7.5KW					

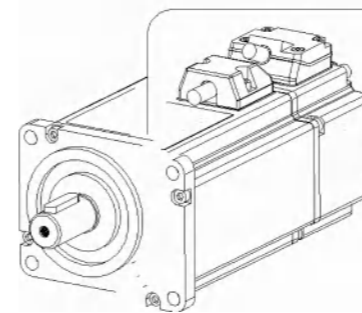

Nameplate	WECON AC SERVO MOTOR	
Model	Model: WD80M-07530S-D2G	
Parameter	Pn: 0.75KW	In: 4.4A
	N: 3000r/min	INS: F
	Tn: 2.39Nm	IP: 65
	M034S7200828B00D0001	Motor Code : XXXXXX
	MADE IN CHINA	
	WECON Technology Co., Ltd.	

Manufacturer code
Motor code

Servo Motors

220V motor model	Flange (mm)	Power (kW)	Rated speed (rpm)	Rated torque (N*m)	Rated current (A)	Allowable overload multiple	Pole pairs	Inertia level
WD40M-01030S-□□□	40	0.1	3000	0.318	1.0	3.0	5	Middle
WD60M-02030S-□□□	60	0.2	3000	0.64	1.7	3.0	5	Middle
WD60M-04030S-□□□	60	0.4	3000	1.27	2.5	3.0	5	Middle
WD60M-06030S-□□□	60	0.6	3000	1.91	3.6	3.0	5	Middle
WD80M-07530S-□□□	80	0.75	3000	2.39	4.4	3.0	5	Middle
WD80M-10030S-□□□	80	1	3000	3.18	5.8	3.0	5	Middle
WD80M-10025S-□□□	80	1	2500	3.82	4.6	3.0	5	Middle
WD130M-10020S-□□□	130	1	2000	4.8	6.0	3.5	5	Middle
WD130M-08515S-□□□	130	0.85	1500	5.41	4.6	3.0	5	Middle
WD130M-15025S-□□□	130	1.5	2500	5.73	6.0	3.0	5	Middle
WD130M-15020S-□□□	130	1.5	2000	7.2	8.5	3.5	5	Middle
WD130M-13015S-□□□	130	1.3	1500	8.28	7.7	3.0	5	Middle
WD130M-20020S-□□□	130	2	2000	9.55	10	3.0	5	Middle
WD130M-26025S-□□□	130	2.6	2500	9.93	10.5	3.0	5	Middle
WD130M-18015S-□□□	130	1.8	1500	11.46	9.8	3.0	5	Middle
WD130M-38025S-□□□	130	3.8	2500	14.5	16	3.0	5	Middle
WD130M-23015S-□□□	130	2.3	1500	14.64	12.4	3.0	5	Middle

220V motor model	Flange (mm)	Power (kW)	Rated speed (rpm)	Rated torque (N*m)	Rated current (A)	Allowable overload multiple	Pole pairs	Inertia level
WD60H-02030S-□□□	60	0.2	3000	0.64	1.8	3.5	5	High
WD60H-04030S-□□□	60	0.4	3000	1.27	2.8	3.5	5	High
WD60H-06030S-□□□	60	0.6	3000	1.91	4.0	3.0	5	High
WD80H-07530S-□□□	80	0.75	3000	2.39	4.8	3.0	5	High
WD80H-10030S-□□□	80	1	3000	3.18	4.8	3.0	5	High
WD80H-10025S-□□□	80	1	2500	3.82	4.8	3.0	5	High
WD80H-10020S-□□□	80	1	2000	4.77	4.8	3.0	5	High
WD130H-15030S-□□□	130	1.5	3000	4.8	6.0	3.0	5	High

220V motor model	Flange (mm)	Power (kW)	Rated speed (rpm)	Rated torque (N*m)	Rated current (A)	Allowable overload multiple	Pole pairs	Inertia level
WE60M-04030S-□□□	60	0.4	3000	1.27	2.6	3.0	4	Middle
WE80M-07530S-□□□	80	0.75	3000	2.39	3.0	3.0	4	Middle
WE80M-10025S-□□□	80	1	2500	4.0	4.4	3.0	4	Middle
WE80M-11030S-□□□	80	1.1	3000	3.5	4.5	3.0	4	Middle
WE80M-12030S-□□□	80	1.2	3000	4.0	4.5	3.0	4	Middle
WE110M-12030S-□□□	110	1.2	3000	4.0	5.0	3.0	4	Middle
WE110M-15030S-□□□	110	1.5	3000	5.0	6.0	3.0	4	Middle
WE110M-18030S-□□□	110	1.8	3000	6.0	6.0	3.0	4	Middle
WE130M-10025S-□□□	130	1	2500	4.0	4.0	3.0	4	Middle
WE130M-13025S-□□□	130	1.3	2500	5.0	5.0	3.0	4	Middle
WE130M-15025S-□□□	130	1.5	2500	6.0	6.0	3.0	4	Middle
WE130M-20025S-□□□	130	2	2500	7.7	7.5	2.9	4	Middle
WE130M-15015S-□□□	130	1.5	1500	10	6.0	2.5	4	Middle
WE130M-26025S-□□□	130	2.6	2500	10	10	2.5	4	Middle
WE130M-23015S-□□□	130	2.3	1500	15	9.5	2.0	4	Middle
WE130M-38025S-□□□	130	3.8	2500	15	13.5	2.0	4	Middle

Servo Motors

380V motor model	Flange (mm)	Power (kW)	Rated speed (rpm)	Rated torque (N*m)	Rated current (A)	Allowable overload multiple	Pole pairs	Inertia level
WD130M-08515T-□□□	130	0.85	1500	5.41	3.1	3.0	5	Middle
WD130M-13015T-□□□	130	1.3	1500	8.28	5.1	3.0	5	Middle
WD130M-18015T-□□□	130	1.8	1500	11.46	6.3	3.0	5	Middle
WD130M-23015T-□□□	130	2.3	1500	14.64	8.5	3.0	5	Middle
WD180M-29015T-□□□	180	2.9	1500	18.6	11.8	3.0	5	Middle

380V motor model	Flange (mm)	Power (kW)	Rated speed (rpm)	Rated torque (N*m)	Rated current (A)	Allowable overload multiple	Pole pairs	Inertia level
WE130M-20025T-□□□	130	2.0	2500	7.7	7.5	2.8	4	Middle
WE130M-26025T-□□□	130	2.6	2500	10	6.0	2.5	4	Middle
WE130M-38025T-□□□	130	3.8	2500	15	8.8	2.0	4	Middle
WE130M-53030T-□□□	130	5.3	3000	17	11	2.0	4	Middle
WE130M-31015T-□□□	130	3.1	1500	20	11.5	2.5	4	Middle
WE130M-42020T-□□□	130	4.2	2000	20	8.5	2.0	4	Middle
WE180M-30015T-□□□	180	3.0	1500	19	7.5	2.5	4	Middle
WE180M-43015T-□□□	180	4.3	1500	27	10	2.5	4	Middle
WE180M-55015T-□□□	180	5.5	1500	35	12	2.0	4	Middle
WE180M-75015T-□□□	180	7.5	1500	48	20	2.0	4	Middle

Note: □□□ Not all motor models include the following categories

A1F : 17-bit single-turn absolute magnetic encoder without brake.

A1G : 17-bit single-turn absolute magnetic encoder with brake.

C1F : 17-bit multi-turn absolute magnetic encoder without brake

C1G : 17-bit multi-turn absolute magnetic encoder with brake.

D2F : 23-bit multi-turn absolute Optical encoder without brake.

D2G : 23-bit multi-turn absolute Optical encoder with brake.

Servo Cable Naming Rules

E	-	J1394	-	R9M	-	3M	X7	-	A1	-	2
①		②		③		④	⑤		⑥		⑦

① 4-core CPU
E:Encoder adapter cable

② Drive side connector
J1394:1394 connector
D15G:DB15 male connector

③ Motor side connector
R9M:9-core rectangular female connector
MC7S:7-core straight female connector
H28K7M:7-core 28mm aviation female connector
CM10:11-core 11mm aviation female connector
MC7P:7-core straight female connector (L2)
R15M:15-core rectangular female connector
H28J15M:15-core 28mm aviation female connector

④ Cable length
3M:3M
5M:5M
7M:7M
... ..

⑤ Number of cores
X5:5 cores
X7:7 cores

⑥ Wire size
A:0.2mm/0.14mm
A1:0.2mm/0.14mm with battery box
... ..

⑦ Others
1:Ordinary cable
2:High flex cable
.....

P	-	U301	-	H28J4M	-	5M	X4	-	C	-	1
①		②		③		④	⑤		⑥		⑦

① Cable type
P:Power adapter cable/brake cable

② Drive side connector
Z3O1:3-core pin-type cold-pressed terminal and 1-core O-type cold-pressed terminal
Z3O3: 3-core pin-type cold-pressed terminal and 3-core O-type cold-pressed terminal
Z4O2:4-core pin-type cold-pressed terminal and 2-core O-type cold-pressed terminal
U3O1:3-core U-type cold-pressed terminal and 1-core O-type cold-pressed terminal
U3O3: 3-core U-type cold-pressed terminal and 3-core O-type cold-pressed terminal
Z6:6-core pin-type cold-pressed terminal
O2:2-core O-type cold-pressed terminal

③ Motor side connector
18A6:6-core 23mm aviation female connector
R4M:4-core rectangular female connector
MC4S: 4-core straight female connector
MC6S: 6-core straight female connector
H28J4M: 4-core 28mm aviation female connector
H32J4M: 4-core 32mm aviation female connector
R2M:2-core rectangular female connector
MC4H: 4-core H-type straight female connector
MC6H:6-core H-type straight female connector

④ Cable length
3M:3M
5M:5M
7M:7M
10M:10M
... ..

⑤ Number of cores
X2:2 cores
X4:4 cores
X6:6 cores
... ..

⑥ Wire size
D:0.5mm
E:0.75mm
B:1.0mm
F:1.5mm
C:2.5mm

⑦ Others
1:Ordinary cable
2:High flex cable

Servo Cable Matching Table

Motor model	Matching drive	Power cable/brake cable	Encoder cable
WD40M-○○○-□□□ WD60M-○○○-□□□ WD60H-○○○-□□□ WE60M-○○○-□□□ WD80M-○○○-□□□ WD80H-○○○-□□□ WE80M-○○○-□□□	VD2 / VD3E (A type)	Power cable: P-Z301-R4M-*MX4 Brake cable: P-O2-R2M-3MX2-D	Single-turn: E-J1394-R9M-*MX5-A
	VD2 / VD3E (B type) VD2 / VD3E (C type)	Power cable: P-U301-R4M-*MX4 Brake cable: P-O2-R2M-3MX2-D	
	VD2F / VD2L	Power cable: P-Z4-R4M-*MX4 Brake cable: P-O2-R2M-3MX2-D	Multi-turn E-J1394-R9M-*MX7-A1
WD60M-○○○-□□□-L WD80M-○○○-□□□-L	VD2 / VD3E (A type)	Withoutbrake: P-Z301-MC4S-*MX4 With brake: P-Z303-MC6S-*MX6	Single-turn E-J1394-MC7S-*MX5-A
	VD2 / VD3E (B type) VD2 / VD3E (C type)	Withoutbrake: P-U301-MC4S-*MX4 With brake: P-U303-MC6S-*MX6	
	VD2F / VD2L	Withoutbrake: P-Z4-MC4S-*MX4 With brake: P-Z4O2-MC6S-*MX6	Multi-turn E-J1394-MC7S-*MX7-A1
WD60M-○○○-□□□-L2 WD80M-○○○-□□□-L2	VD2 / VD3E (A type)	Withoutbrake: P-Z301-MC4S-*MX4 With brake: P-Z303-MC6S-*MX6	Single-turn E-J1394-MC7P-*MX5-A
	VD2 / VD3E (B type) VD2 / VD3E (C type)	Withoutbrake: P-U301-MC4S-*MX4 With brake: P-U303-MC6S-*MX6	
	VD2F / VD2L	Withoutbrake: P-Z4-MC4S-*MX4 With brake: P-Z4O2-MC6S-*MX6	Multi-turn E-J1394-MC7P-*MX7-A1
WD60H-○○○-□□□-L2 WD80H-○○○-□□□-L2	VD2 / VD3E (A type)	Withoutbrake: P-Z301-MC4H-*MX4 With brake: P-Z303-MC6H-*MX6	Single-turn E-J1394-MC7P-*MX5-A
	VD2F / VD2L	Withoutbrake: P-Z4-MC4H-*MX4 With brake: P-Z4O2-MC6H-*MX6	
WE110M-○○○-□□□ WE130M-○○○-□□□	VD2 / VD3E (A type)	Power cable: P-Z301-H28J4M-*MX4 Brake cable: No need	Single-turn E-J1394-H28K7M-*MX5-A
	VD2 / VD3E (B type) VD2 / VD3E (C type)	Power cable: P-U301-H28J4M-*MX4 Brake cable: No need	
	VD2F / VD2L	Power cable: P-Z4-H28J4M-*MX4 Brake cable: No need	Multi-turn E-J1394-H28K7M-*MX7-A1
WD130M-○○○-□□□ WD130H-○○○-□□□	VD2 / VD3E (A type)	Withoutbrake: P-Z301-18A6-*MX4 With brake: P-Z303-18A6-*MX6	Single-turn E-J1394-CM10-*MX5-A
	VD2 / VD3E (B type) VD2 / VD3E (C type)	Withoutbrake: P-U301-18A6-*MX4 With brake: P-U303-18A6-*MX6	
	VD2F / VD2L	Withoutbrake: P-Z4-18A6-*MX4 With brake: P-Z4O2-18A6-*MX4	Multi-turn E-J1394-CM10-*MX7-A1
WD130M-○○○-□□□-L2	VD2 / VD3E (A type)	Withoutbrake: P-Z301-18A6-*MX4 With brake: P-Z303-18A6-*MX6	Single-turn E-J1394-MC7P-*MX5-A
	VD2 / VD3E (B type) VD2 / VD3E (C type)	Withoutbrake: P-U301-18A6-*MX4 With brake: P-U303-18A6-*MX6	
	VD2F / VD2L	Withoutbrake: P-Z4-18A6-*MX4 With brake: P-Z4O2-18A6-*MX4	Multi-turn E-J1394-MC7P-*MX7-A1
WE180M-○○○ □□□ WD180M-○○○ □□□	VD2 / VD3E (B type) VD2 / D3E (C type)	Power cable: P-U301-H32J4M-*MX4 Brake cable: No need	Single-turn E-J1394-H28K7M-*MX5-A
			Multi-turn E-J1394-H28K7M-*MX7-A1

Note: ○○○ is corresponding to motor power, motor speed, voltage level respectively

WECON IIoT

Products and Solutions



WECON V-NET&Gateway Architecture

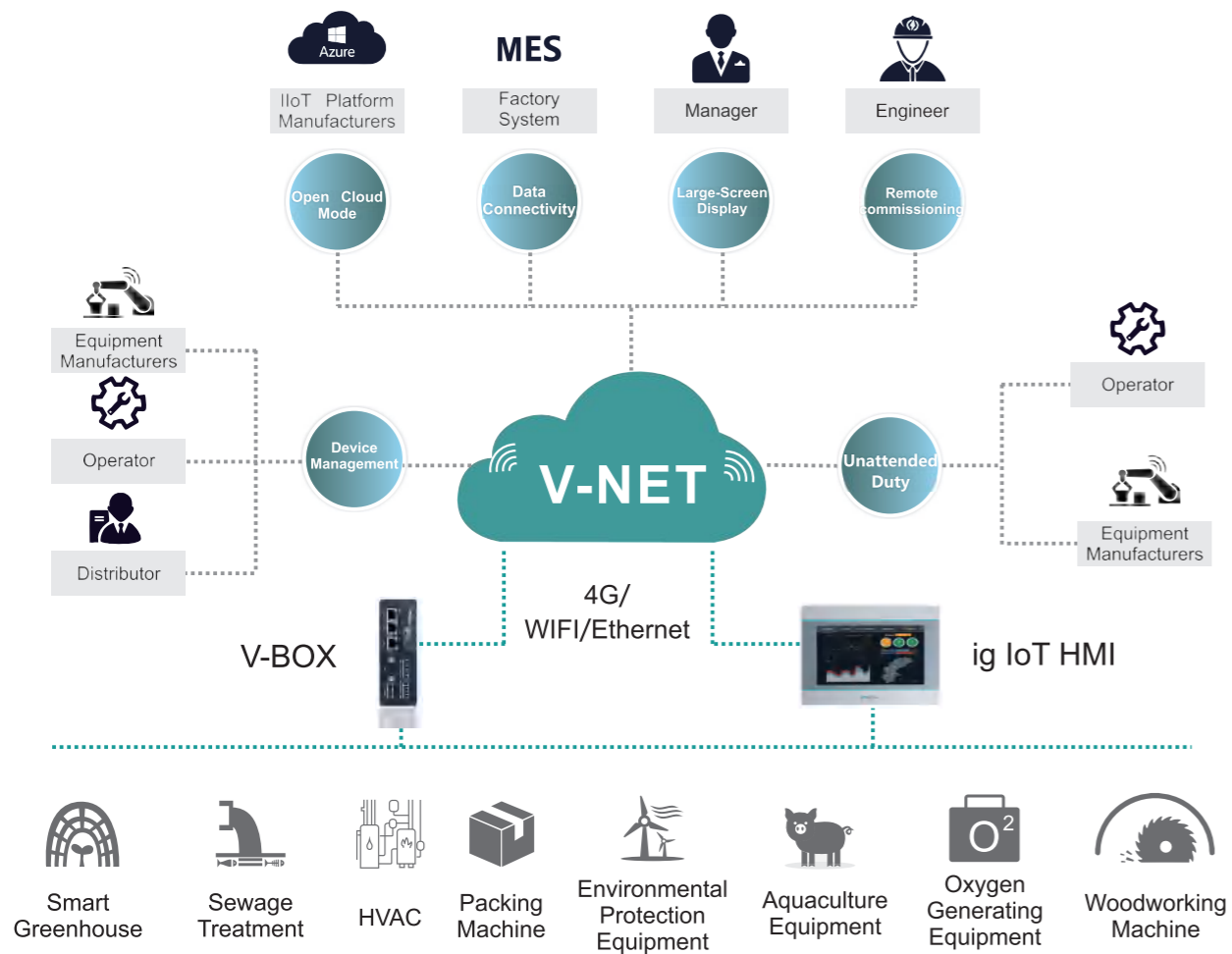

WECON V-NET&Gateway Functions

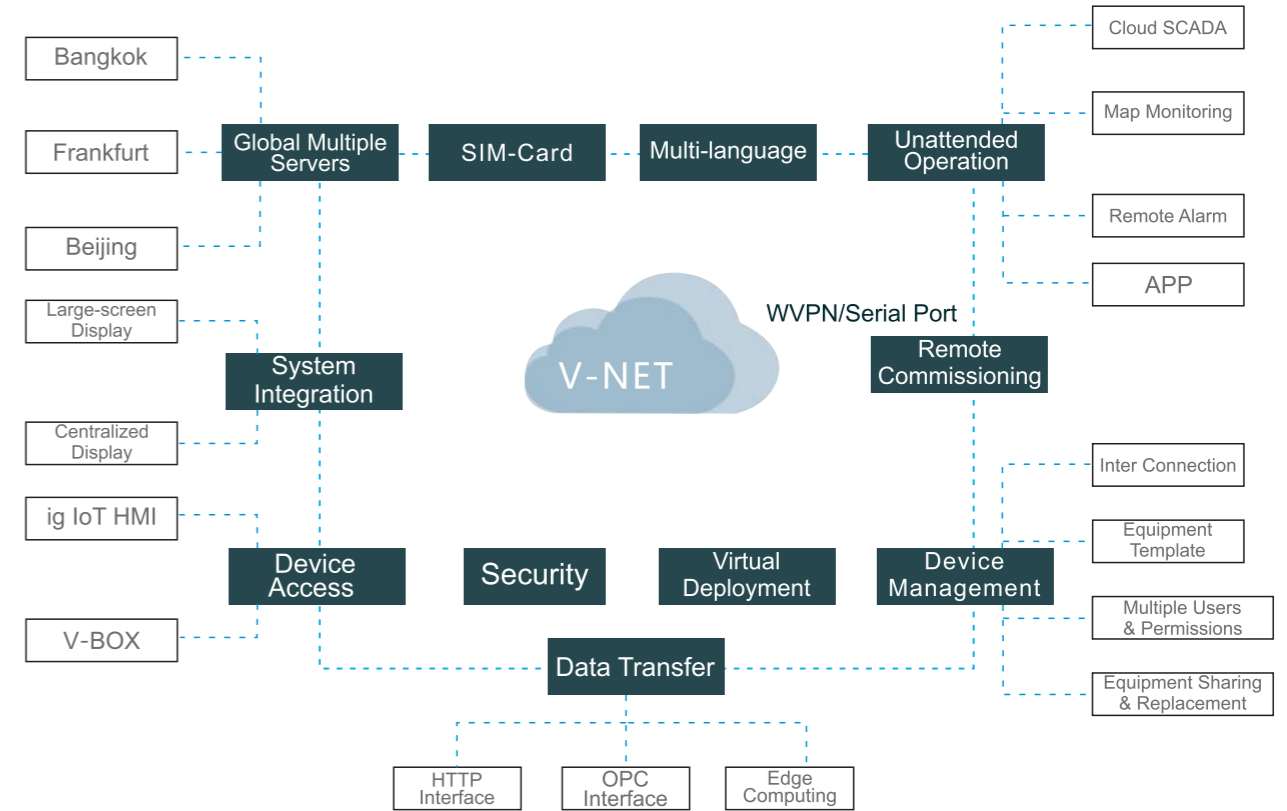

Device Management

All in One

To locate the devices accurately through map index, category search, fuzzy search, etc.

One-key Configuration

To download and modify the configuration of the V-BOX of the same model by using the template function.

Role Management

Managers can assign V-NET permissions to users at the corresponding levels by establishing users at various levels (4 levels in total), no matter how many devices there are, they could be managed by one person.

Global Servers

Server Location	Providers	Country or Region
Beijing	HUAWEI CLOUD	China
Bangkok	HUAWEI CLOUD	Southeast Asia, East Asia and Oceania
Frankfurt	AWS by Amazon	Europe, America, Middle East and India

Multilingual

- Chinese & English for main interface;
- User-defined three kinds of languages supported in project of Cloud SCADA;
- Languages switchable.

WECON V-BOX



Standard with 3 Serial ports & 3 Ethernet (H Series), Support RS485/RS422, Optional for WiFi, 4G, GPS

Built-in IOs



Built-in 2*DI & 2*DO relay (H Series only)

Pass-through Function



Support WVPN Pass-through, Serial Port Pass-through to realize PLC remote debugging or download

Edge Computing



Simple logic control could be realized by built-in Lua Script.

OpenCloud Mode



V-BOX can be connected to third-party platforms through OpenCloud Mode.

Protocols



300+ protocols of main brands PLC with ethernet and serial ports

Installations



DIN rail & mounting Hole installation

Quick Access



Connect to V-NET easily by plugging in network cables or IoT SIM card (China cloud only)

Indicators



V-NET Connection indicator
4G Signal Intensity indicator
PLC Communication Status indicator

V-BOX E Series Specifications

General			
Model		E-00	E-4G
Item	Specifications		
CPU		ARM9	
Storage	Flash	128MB	
	RAM	DDRII 64MB	
	SD Card	N/A	
I/O Ports	USB	OTG : USB HOST/USB DEVICE	
	Serial Ports	COM1: RS232, RS422/RS485(2 in 1)	
	Ethernet	1 EthernetPort	
	WIFI Module	N/A	
Power	4G Module	N/A	4G
	Power Supply	24V DC (12~28V DC)	
	Power Consumption	< 10W	
Dimension	Enclosure	Cold-rolled steel sheets	
	Dimension (W*H*D)	101.0mm*73.2mm*26.8mm	
	Wall Hanging Dimension	110.0mm*15.6mm	
	Weight (KG)	0.26	
Environment	Vibration Resistance	IEC61131-2 Standard	
	Storage Temperature	-20°C~70°C	
	Working Temperature	-10°C~60°C	
	Relative Humidity	10~85%RH (Non-condensing)	
CE Certification		CE Marked	
FCC Certification		FCC Class A Marked	
Real-time Monitoring Points		200	250
Alarm Monitoring Points		50	100
History Monitoring Points		20	50
History Storage/Storage capacity		60 Days/1 Million	90 Days/1 Million
Normal Pass-through		YES	
WVPN Pass-through		N/A	
Edge Computing		N/A	YES
API Interface		YES	
Remote Update		YES	
Configuration download/upload		YES	
Off-line Transmission		YES	
GPS		N/A	LBS
E-4G model frequency code			
LTE FDD	LTE TDD	WCDMA	GSM
B1/B3/B5/B8	B34/B38/B39/B40/B41	B1/B5/B8	900/1800MHz

Remark: Please contact us for confirmation about 4G Compatibility before purchase.

V-BOX H Series Specifications

General					
					
Model	H-00	H-WF	H-4G/H-SG	H-AG	
Item	Specifications				
CPU	Cortex A7				
Storage	Flash	128MB			
	RAM	DDRIII 128MB			
I/O Ports	USB	HOST/DEVICE: USB OTG Switch			
	Serial Ports	COM1:RS232, RS422/RS485 (2 in 1)			
		RS485(2 in 1) 【COM2: RS485, COM3: RS485】			
	Ethernet	3 EthernetPorts			
	WIFI Module	N/A	YES	N/A	N/A
	4G Module	N/A	N/A	4G	4G (Global)
	I/O	2 inputs with optocoupler isolation;2 relay outputs			
Power	Power Supply	24V DC (12~28V DC)			
	Power Consumption	<10W			
Dimension	Enclosure	PC+ABS			
	Dimension (W*H*D)	131.0mm*100.5mm*46.0mm			
	Weight (KG)	0.3			
Environment	Vibration Resistance	IEC61131-2Standard			
	Storage Temperature	-20°C~70°C			
	Working Temperature	-10°C~60°C			
	Relative Humidity	10~85%RH (Non-condensing)			
CE Certification	CE Marked				
FCC Certification	FCC Class A Marked				
Real-time Monitoring Points	300	300	500	600	
Alarm Monitoring Points	200	200	300	300	
History Monitoring Points	50	50	100	100	
History Storage/Storage capacity	90 Days/1Million		180 Days/1 Million		
Normal Pass-through	YES				
WVPN Pass-through	N/A	YES	YES	YES	
Edge Computing	YES				
API Interface	YES				
Remote Update	YES				
Configuration download/upload	YES				
Off-line Transmission	YES				
GPS	N/A		LBS/GPS	LBS	
H-4G model frequency code					
LTE FDD	LTE TDD	TD-SCDMA	WCDMA	CDMA	GSM
B1/B3/B5/B8	B34/B38/B39/B40/B41	B34/B39	B1/B8	BC0	900/1800MHz
H-AG model frequency code					
LTE FDD	LTE TDD	UMTS		GSM	
B1/B2/B3/B4/B5/B7/B8/B12/B13/B18/ B19/B20/B25/B26/B28	B38/B39/B40/B41	B1/B2/B4/B5/B6/B8/B19	B2/B3/B5/B8		

Remark: Please contact us for confirmation about 4G Compatibility before purchase.

V-BOX RE&RH Series Specifications

General						
						
Model	RE-00	RE-4G	RH-WF			
Item	Specifications					
CPU	HighPerformance CPU					
Storage	Flash	128MB	8GB			
	RAM	64MB	2GB			
	SD Card	N/A	YES			
I/O Ports	USB HOST	OTG : USB HOST /USB DEVICE		USB 2.0x1; USB 3.0x1		
	USB DEVICE			Type-C x 1		
	Serial Ports	COM1: RS232, RS422/RS485 (2 in 1)		COM1: RS232, RS422/RS485		
				COM2: RS485		
	Ethernet	1* Ethernet		2 * Ethernet (10/100M)		
	WIFI Module	N/A		YES		
	4G Module	N/A	4G	N/A		
Power	Power Supply	24V DC (12~28V DC)				
	Power Consumption	<10W				
Dimension	Enclosure	Cold-rolledsteel sheets		Plastic+ABS(Polycarbonate)		
	Dimension (W*H*D)	101.0mm*73.2mm*26.8mm		125.0mm*93.7mm*51.0mm		
	Weight (KG)	0.26		0.30		
Environment	Vibration Resistance	IEC61131-2Standard				
	Storage Temperature	-20°C~70°C				
	Working Temperature	-10°C~60°C				
	Relative Humidity	10~90%RH (Non-condensing)				
CE Certification	CE Marked					
FCC Certification	FCC Class A Marked					
Real-time Monitoring Points	100				300	
Alarm Monitoring Points	20				200	
History Monitoring Points	50				100	
History Storage/Storage capacity	60 Days/1 Million					
Normal Pass-through	YES					
WVPN Pass-through	YES					
Edge Computing	YES					
API Interface	YES					
Remote Firmware Update	N/A					
Configuration download/upload	N/A					
Off-line Transmission	YES					
GPS	N/A	LBS	N/A			
Big Screen Monitoring	YES					
HDMIPort	N/A		YES			
E-4G model frequency code						
LTE FDD	LTE TDD	WCDMA		GSM		
B1/B3/B5/B8	B34/B38/B39/B40/B41	B1/B5/B8		900/1800MHz		

Remark: Please contact us for confirmation about 4G Compatibility before purchase.

VB Series AC Drive

Power Range: Single Phase Input & Three Phase Output(220V): 0.75~2.2kW;
 Three Phase Input & Three Phase Output (380V/415V/440V): 0.75~400kW

The VB series is a new high-performance vector general-purpose VFD that further enhances stability and reliability through technical upgrades and product optimization, and it is suitable for complex drives applications.



- SVC/VF Control
- 0-1000Hz
- 6 channels DI, 2 channels AI, 2 channels Relay
- High reliability design

Application

Lifting machinery, tension machinery, cutting and forging machinery, large inertia braking, metal processing, woodworking, rubber and plastic machinery, textile machinery, etc.

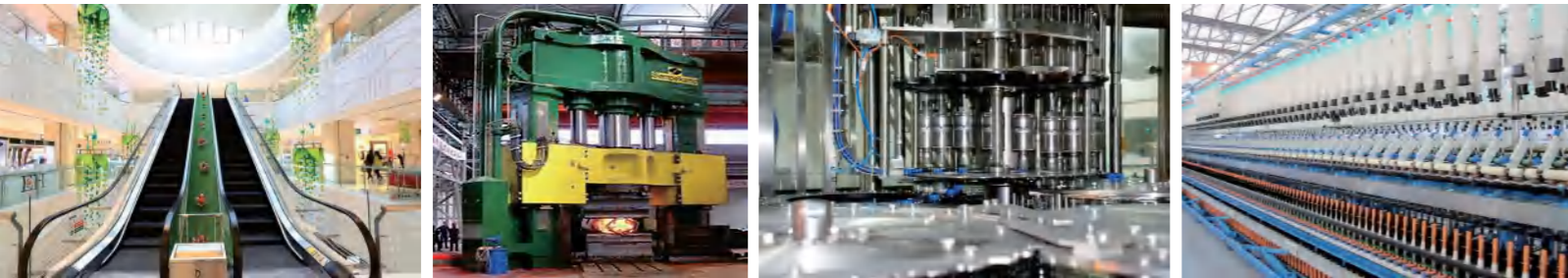

Technical specification sheet

Control characteristic	Control Mode	V/F Control; Sensorless Vector Control (SVC); Torque Control
	Starting Torque	G Type: 0.5Hz/150 % (SVC); P Type: 0.5Hz/100%
	Speed Adjustment Range	1 : 100 (SVC)
	Speed Holding Precision	± 0.5 % (SVC)
	Overload Capability	G Type: 150 % rated current for 60s ; 180 % rated current for 1s P Type: 120 % rated current for 60s ; 150 % rated current for 1s
Input/output	Input Voltage	220V; fluctuation range: 220V(-15%)~220V(+15%); 380V/415V/440V; fluctuation range: 380V(-15%)~440V(+10%)
	Input Frequency	50/60Hz, fluctuation range: ±5%
	Output Voltage	0-rated input voltage
	Output Frequency	SVC: 0~320Hz, V/F: 0~1000Hz
Input/output Terminals	Analog Input	2 channels
	Digital Input	6 channels
	Analog Output	2 channels
	Digital Output	1 channels
	Relay Output	2 channels
	RS485 Communication Terminal	1 channels
	Power Supply	2 channels, 1 channels 10V,1 channels 24V
Application environment	Attitude	Lower than 1000m, service is derated capability above 1000m, derate 1% capacity every 100m increased in height
	Environment Temperature	-10°C ~ + 40°C (service is derated capability for 40°C ~ 50°C)
	Humidity	≤95%RH, no water condensation
	Vibration	< 5.9m/s ² (0.6g)
	Storage Temperature	- 40°C ~ + 60°C

Model number description

VB - 4 T 18R5GB /022PB

VB: Product Series 2: 220VAC, 4: 380V/415V/440V AC S: Single phase, T: Three phase	022: 22kW P: Variable Torque Load B: Braking Unit Within 18R5: 18.5kw R: Refers to Decimal Point G: Constant Torque Load B: Braking Unit Within
--	---

■ Specification and selection guide

Voltage grade	Power		Rated input current(A)	Rated output current(A)	Series No.	2:220V 4:380V	S:single phase T: three-phase	Adaptive motor power	G: general type P: fan type	B:integrated with brake function
	kW	HP								
Single phase 220VAC ±15%	0.75	1.0	8.2	4.5	VB	2	S	R75	G	B
	1.5	2.0	14	7	VB	2	S	1R5	G	B
	2.2	3.0	23	9.6	VB	2	S	2R2	G	B
Three phase 380VAC ±15%	0.75	1.0	3.4	2.1	VB	4	T	R75	G	B
	1.5	2.0	5	3.8	VB	4	T	1R5	G	B
	2.2	3.0	5.8	5.1	VB	4	T	2R2	G	B
	4/5.5	5.5/7.5	10.5/14.6	9/13	VB	4	T	4/5R5	G/P	B
	5.5/7.5	7.5/10	14.6/20.5	13/17	VB	4	T	5R5/7R5	G/P	B
	7.5	10.2	20.5	17	VB	4	T	7R5	G	B
	11/15	15/20	26/35	25/32	VB	4	T	011/015	G/P	B
	15/18.5	20/25	35/38.5	32/37	VB	4	T	015/18R5	G/P	B
	18.5/22	25/30	38.5/46	37/45	VB	4	T	18R5/022	G/P	B
	22/30	30/40	46.5/62	45/60	VB	4	T	022/030	G/P	B
	30/37	40/50	62/76	60/75	VB	4	T	030/037	G/P	/
	37/45	50/60	76/92	75/91	VB	4	T	037/045	G/P	/
	45/55	60/70	92/113	91/110	VB	4	T	045/055	G/P	/
	55/75	70/100	113/157	112/150	VB	4	T	055/075	G/P	/
	75/90	100/125	157/180	150/170	VB	4	T	075/090	G/P	/
	90/110	125/150	180/214	170/210	VB	4	T	090/110	G/P	/
	110/132	150/180	214/256	210/253	VB	4	T	110/132	G/P	/
	132/160	180/220	256/307	253/304	VB	4	T	132/160	G/P	/
	160/185	220/255	307/345	304/340	VB	4	T	160/185	G/P	/
	185/200	255/275	345/385	340/377	VB	4	T	185/200	G/P	/
200/220	275/300	385/430	377/426	VB	4	T	200/220	G/P	/	
220/250	300/340	430/468	426/465	VB	4	T	220/250	G/P	/	
250/280	340/380	468/525	465/520	VB	4	T	250/280	G/P	/	
280/315	380/430	525/590	520/585	VB	4	T	280/315	G/P	/	
315/355	430/480	590/665	585/650	VB	4	T	315/355	G/P	/	
355/400	480/545	665/785	650/725	VB	4	T	355/400	G/P	/	
400	545	785	725	VB	4	T	400	G	/	

■ Dimensions(mm)

0.75kW-7.5kW dimension

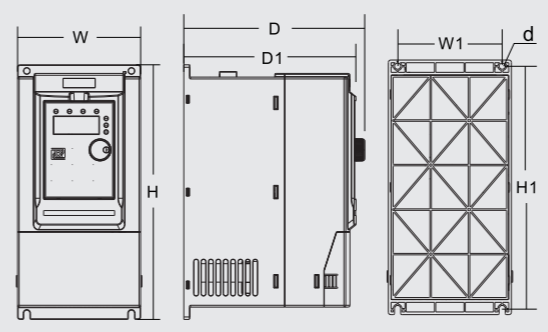

Inverter Model	Outline size				Installation dimension		Opening size
	H	W	D	D1	H1	W1	d
VB-2SR75GB	187	88	138	130	177	73	5
VB-2S1R5GB							
VB-2S2R2GB							
VB-4TR75GB							
VB-4T1R5GB							
VB-4T2R2GB	207	100	147	139	197	85	5
VB-4T004GB/5R5PB	247	130	167	159	237	113	5
VB-4T5R5GB/7R5PB							
VB-4T7R5GB							

11kW-185kW dimension

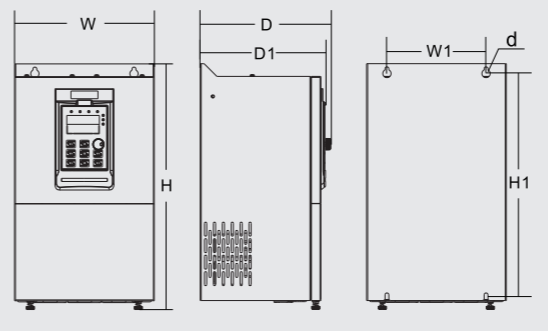

Inverter Model	Outline size				Installation dimension		Opening size
	H	W	D	D1	H1	W1	d
VB-4T011GB/015PB	348	182	211	196	331	156	6
VB-4T015GB/18R5PB							
VB-4T18R5GB/022PB							
VB-4T022GB/030PB	373	220	205	190	356	156	6
VB-4T030G/037P							
VB-4T037G/045P	435	256	222	208	419	170	6
VB-4T045G/055P							
VB-4T055G/075P	543	310	280	265	523	245	10
VB-4T075G/093P							
VB-4T093G/110P	580	358	328	314	560	270	10
VB-4T110G/132P							
VB-4T132G/160P	869	502	355	342	842	320	10
VB-4T160G/185P							
VB-4T185G/200P							

200kW-400kW dimension

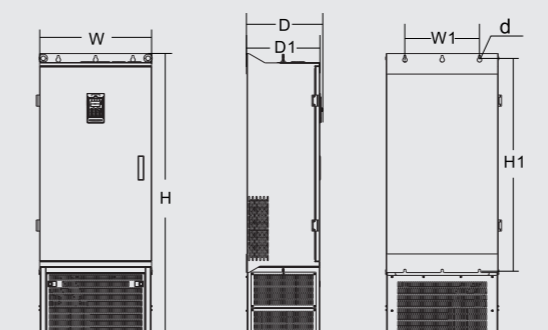

Inverter Model	Outline size				Installation dimension		Opening size
	H	W	D	D1	H1	W1	d
VB-4T200G/220P	1570	600	408	398	1147	400	12
VB-4T220G/250P							
VB-4T250G/280P							
VB-4T280G/315P	1696	800	408	398	1266	520	12
VB-4T315G/355P							
VB-4T355G/400P	1696	800	408	398	1266	520	12
VB-4T400G							

VM

Economical Frequency Converter



Single-phase 220V: 0.75~2.2kW
 Three-phase 380V: 0.75~7.5kW



Compact in size



Better protection function



Professional motor drive
 Superior performance



Simple installation
 Convenient speed regulation



Compatible with synchronous
 Motor & asynchronous motor



The product is safer to use

■ Technical specification sheet

Item	Description	
Control characteristic	Control mode	V/F control
	Output frequency range	0~1000Hz
	Starting torque	0.5Hz/130%
	Carrier frequency	0.6~15.0kHz
	Overload capacity	150% rated current 60s, 180% rated current 1s
	Torque lift	Automatic torque lift/manual torque lift 0.1 ~ 30.0%
I/O terminals	Analog input	1 way
	Digital input	4 way
	Analog output	1 way
	Relay output	2.2kW (including) models below 1 normal open; For 4kW or more models, 1 channel is normally open and 1 channel is normally closed
	RS485 communication terminal	1 Integrated in the RJ45 cable port
	10V power terminal	1 way
	24V power terminal	1 way
Basic functions	Run command channel	Three channels: set operation panel, control terminal, and RS485 communication control, which can be switched in various ways
	Frequency source	Digital set, panel potentiometer set, analog voltage set, analog current set, RS485 communication set, PID control set, switchable by many ways
	DC braking function	DC braking frequency: 0-50Hz, braking time: 0-60s Braking action current value: 0-150%
	V/F curve	Linear; 1.1-1.9 power; Square type; Customize V/F curves
	Simple PLC, multi-speed control	Up to 15 speed to achieve simple PLC operation
	Integrated PID	It is convenient to realize process control closed-loop control system
	Protection function	Input/output phase loss protection, overcurrent protection, overvoltage protection, undervoltage protection, overheat protection, overload protection, power-on short circuit detection etc
	LED display	5-bit LED display
	Parameter locking function	The parameter read-only function can be set to prevent misoperations
	Automatic voltage adjustment AVR function	When the grid voltage changes, the output voltage can be kept constant automatically
Application environment	Operation place	Indoor, free from direct sunlight, no dust, no corrosive gas, no combustible gas, no oil mist, no water mist, no drip or salt, etc.
	Altitude	Lower than 1000m. Service in derated capacity when above 1000m. Derate 1% capacity every 100m increase in height.
	Ambient temperature	-10 °C to +50 °C (If the ambient temperature is 40°C to 50 °C, please reduce the amount to use)
	Humidity	≤ 95%RH, no water condensation
	Vibration	< 5.9m/s ² (0.6G)
	Storage temperature	-25°C ~ 60°C
	Protection class	IP20

SELECTION GUIDE

Model	Rated Power	Power capacity	Input current	Output current	Motor G/P	
	kW	kVA	A	A	kW	HP
Single 220V input three-phase 0-220V output						
VM-2SR75	0.75	1.5	8.2	4	0.75	1
VM-2S1R5	1.5	3	14	7	1.5	2
VM-2S2R2	2.2	4	23	9.6	2.2	3
Three 380V output three-phase 0-380V output						
VM-4TR75	0.75	1.5	3.4	2.5	0.75	1
VM-4T1R5	1.5	3	5	3.8	1.5	2
VM-4T2R2	2.2	4	5.8	5.1	2.2	3
VM-4T004	4	5.9	10.5	9	4	5.5
VM-4T5R5	5.5	8.9	14.6	13	5.5	7.5
VM-4T7R5	7.5	11	20	17	7.5	10

DIMENSION (UNIT:MM)

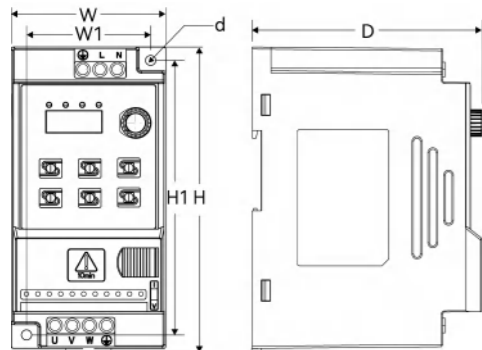

Model	Outline size			Installation dimension		Opening size
	H	W	D	H1	W1	d
VM-2SR75	142	72	116	130	59	5
VM-2S1R5						
VM-2S2R2						
VM-4TR75						
VM-4T1R5						
VM-4T2R2						

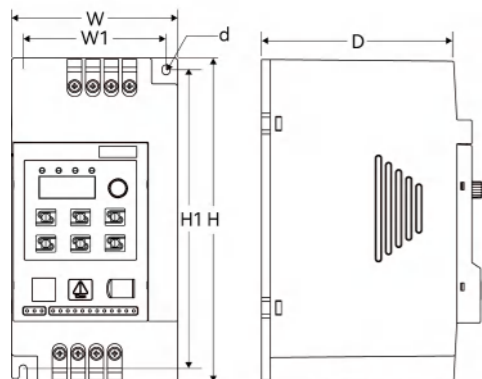

Model	Outline size			Installation dimension		Opening size
	H	W	D	H1	W1	d
VM-4T004	225	115	154	208	99	5.5
VM-4T5R5						
VM-4T7R5						

SELECTION GUIDE

VM Series Inverter could be used in Packaging Machinery, Wood Machinery, Food Machinery, Conveying Machinery, Printing Machinery, Fan, Small Water Pump and so on.

